

INSTALLATION MANUAL

11612

Level of Difficulty

Easy

Installation difficulty levels are based on time and effort involved and may vary depending on the installer level of expertise, condition of the vehicle and proper tools and equipment.

Weight Carrying Capacity

Gross trailer weight (GTW)	2,000 lbs.
Tongue weight (TW)	200 lbs.

Parts List

You will be using existing hardware.

Tools Required

Ratchet	Flathead screwdriver
Socket, 7mm	Trim panel pry tool
Socket, 15mm	Utility knife
Socket extension, 3"	Gloves
Torque wrench	Safety glasses
Torx bit, T-15	--

* For a tools reference guide visit curtmfg.com/trailer-hitch-installation

⚠ WARNING

Never exceed the vehicle manufacturer's recommended towing capacity.

Product Photo



NOTICE

Visit www.curtmfg.com for a full-color copy of this instruction manual, as well as helpful videos, guides and much more!

Before you begin installation, read all instructions thoroughly.

Proper tools will improve the quality of installation and reduce the time required.

This installation requires:

- Use of existing hardware
- Trimming of the rear bumper fascia
- Part removal (wheel well trim, taillight, rear bumper fascia and bumper beam removal)
- Caulk around the bumper beam

Periodic inspection of the trailer hitch should be performed to ensure all mounting hardware remains tight and structural components are secure.

To help prevent damage to the product or vehicle, refer to the specified torque specifications when securing hardware during the installation process.

SAFETY INSTRUCTIONS

Safety glasses should be worn at all times while installing this product.

We recommend wearing gloves while using cutting tools.

Product Registration and Warranty

CURT stands behind our products with industry-leading warranties. To get copies of the product warranties, register your purchase or provide feedback, visit: warranty.curtgroup.com/surveys

ASSEMBLY

NOTICE

You will be using existing vehicle hardware

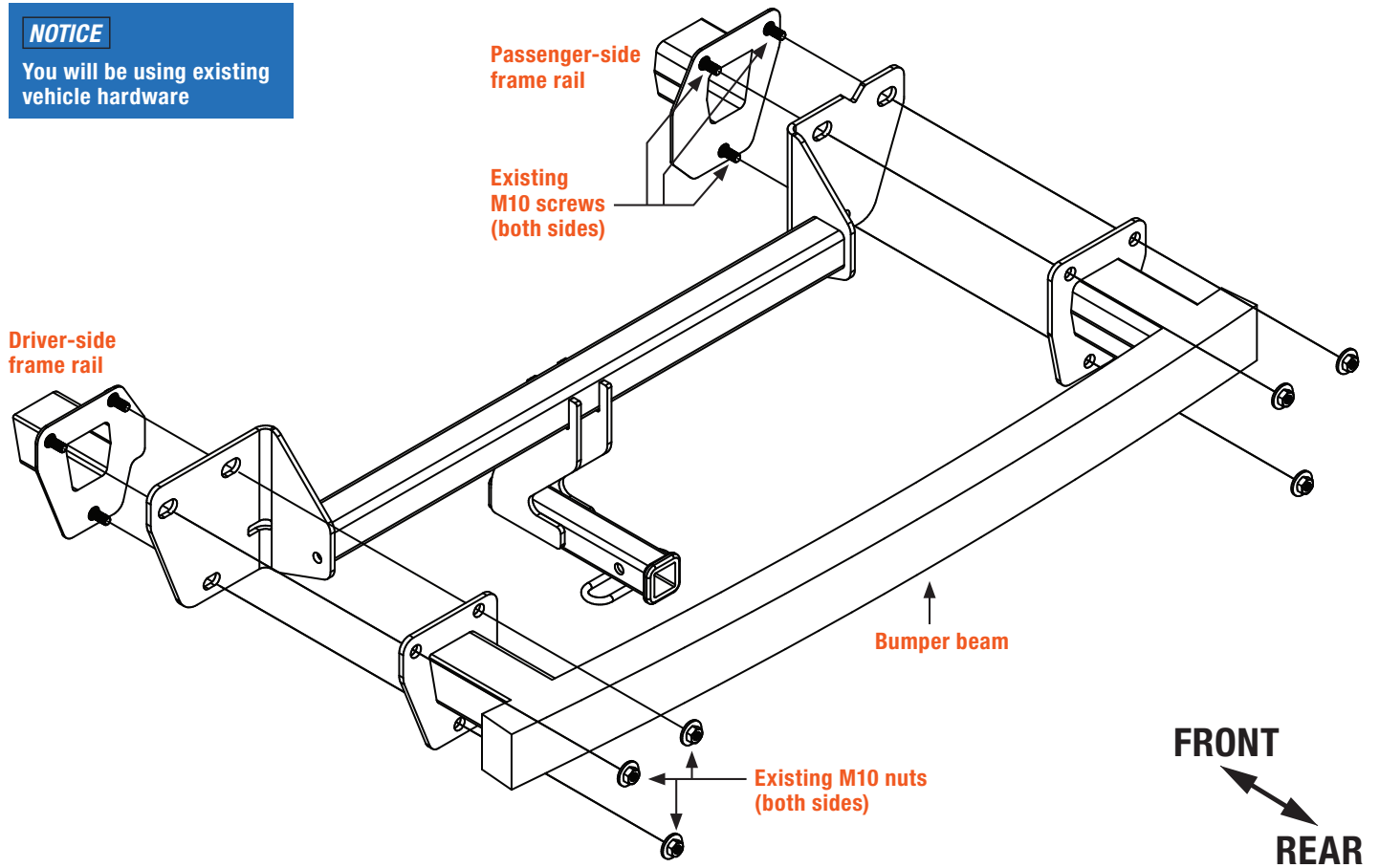

Step 1

Gently remove the wheel well trim and unscrew the front, topmost screw on the fascia on each side. Remove the wheel well trim rivets from the vehicle and reattach to the wheel well trim.

Set the wheel well trims and screws aside for reinstallation in Step 10.

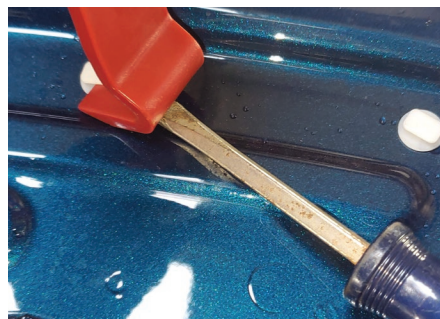

Step 2

Open the hatch and remove one screw on each side. Set the screws aside for reinstallation in Step 10.

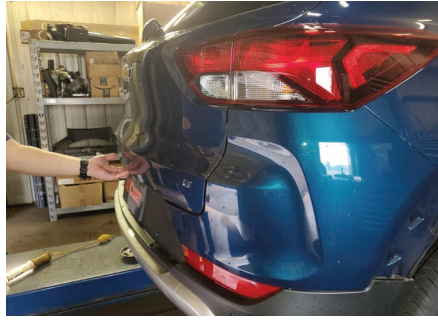

Step 3

Remove the four innermost push pins in the underbody panel and one screw from each side of the vehicle's underbody panel near the wheel wells.

Remove three screws in the wheel well on each side of the vehicle.

You will reinstall all fasteners in Step 10.

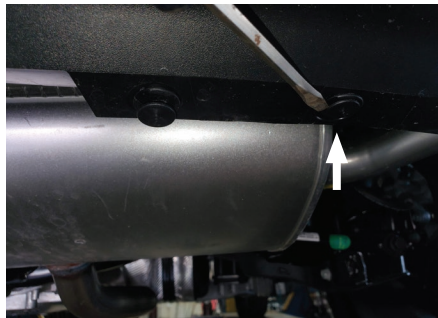

Step 4

On the driver side, open the two access covers to reveal the taillight screws. Unscrew the two screws and gently pry on the fascia. Remove the taillight by pulling rearward on both sides of the light. Set the screws and taillight aside for reinstallation in Step 10.

Note: Make sure electrical wires are not damaged by supporting the taillight.



Step 5

Gently pull on the driver-side rear bumper fascia until you reach the edge of the taillight.

On Chevrolet Trailblazer only: Press on the tab located inside of the rear bumper fascia near where the taillight and the hatch intersect.

For all vehicles:

Repeat Steps 4 and 5 on the passenger side.

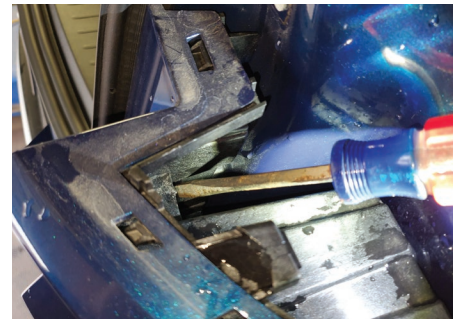

Step 6

Remove the rear bumper fascia by gently pulling on the remainder of the rear bumper fascia. If applicable, disconnect all electrical connectors.

You will reinstall the rear bumper and all electrical connectors in Step 10.



Step 7

If applicable, remove all electrical connectors from the frame. Trim the caulk around the bumper beam on both sides. You will be reinstalling the electrical connectors in Step 10.

Note: Ensure all electrical connectors are out of the way when trimming the caulk.



Step 8

Remove the bumper beam by unscrewing the three M10 nuts on both sides of the vehicle.

You will reinstall the bumper beam and M10 nuts in Step 9.

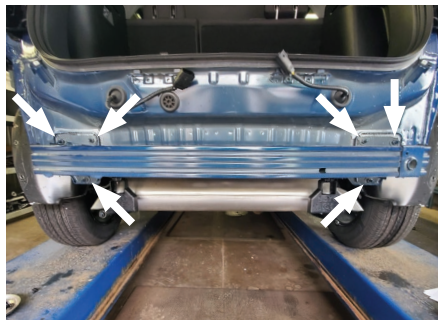

Step 9

Raise the trailer hitch into position over the existing M10 screws on both sides of the vehicle. Place the bumper beam over hitch.

Loosely install on the three removed M10 nuts from Step 8 on both sides of the vehicle.

Note: Ensure any electrical connectors are out of the way for hitch and bumper beam installation.

Torque all M10 hardware to 32 lb-ft.

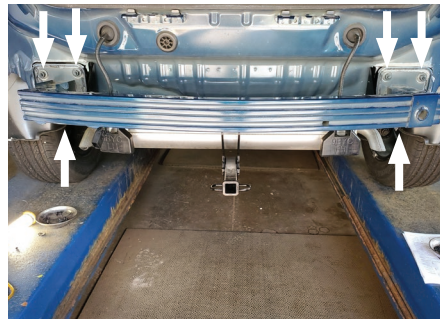

Step 10

Trim the underbody panel to 2-5/8" wide x 1-3/8" tall, as shown.

Reinstall all electrical connectors, the rear bumper fascia, the taillights and all fasteners removed in Steps 1-4 and 6-7.

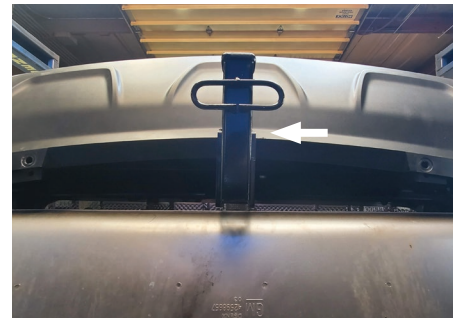
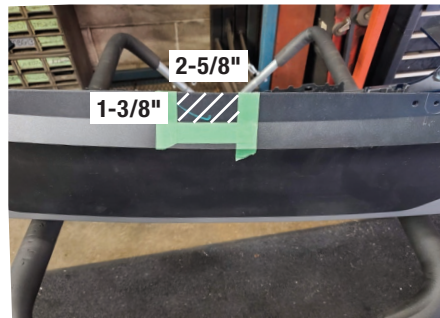

Final Installed Image



TOWING BASICS & SAFETY INFORMATION

For information on safely towing your trailer, visit [curtmfg.com/understanding-towing](https://www.curtmfg.com/understanding-towing).

