

YEARS: 2016-PRESENT

MAKE: CADILLAC / CHEVROLET

MODEL: CTS(V) / CAMERO

STYLE: SEDAN / COUPE

WARNING: NEVER EXCEED YOUR VEHICLE MANUFACTURER'S RECOMMENDED TOWING CAPACITY
 For more information log onto www.curtmfg.com & for helpful towing tips log onto www.hitchinfo.com

WEIGHT CARRYING:
 TRAILER WEIGHT: 2,000 LBS.
 TONGUE WEIGHT: 200 LBS.

WARNING:
 ALL NON-TRAILER (WHEEL-LESS) LOADS APPLIED TO THIS PRODUCT MUST BE SUPPORTED BY 18050 STABILIZING STRAPS. PLEASE SEE THE CURT CATALOG OR VISIT US ONLINE AT WWW.CURTMFG.COM FOR FURTHER INFORMATION.

PRO INSTALL TIME: 45 MIN.
NOVICE INSTALL TIME: 45 MIN.

IF YOU ARE HESITANT TO UNDERTAKE THIS TASK ON YOUR OWN, CONTACT AN AUTHORIZED CURT INSTALLER FOR ADDITIONAL ASSISTANCE.

INSTALLATION REQUIRES:

SAFETY GLASSES	AVIATION SHEARS	TORQUE WRENCH
8" SOCKET EXTENSION	RATCHET	T15 TORXBIT SOCKET
T20 TORXBIT SOCKET	T45 TORXBIT SOCKET	SOCKETS 7mm 8mm 15mm
PRY BAR		

INSTALLATION TIPS:

- BEFORE YOU BEGIN INSTALLATION, READ ALL INSTRUCTIONS THOROUGHLY.
- TO EASE INSTALLATION, 2 PEOPLE MAY BE REQUIRED.
- USING PROPER TOOLS WILL GREATLY IMPROVE THE QUALITY OF THE INSTALL AND REDUCE THE TIME REQUIRED.
- NEED HELP OR HAVE SOME QUESTIONS? CALL TECHNICAL SUPPORT AT 877.287.8634

LEVEL OF DIFFICULTY: MODERATE

EASY	MODERATE	CHALLENGING
	NO DRILLING REQUIRED	
	TEMPORARILY REMOVE BUMPER FASCIA	
	TRIM REAR FASCIA	

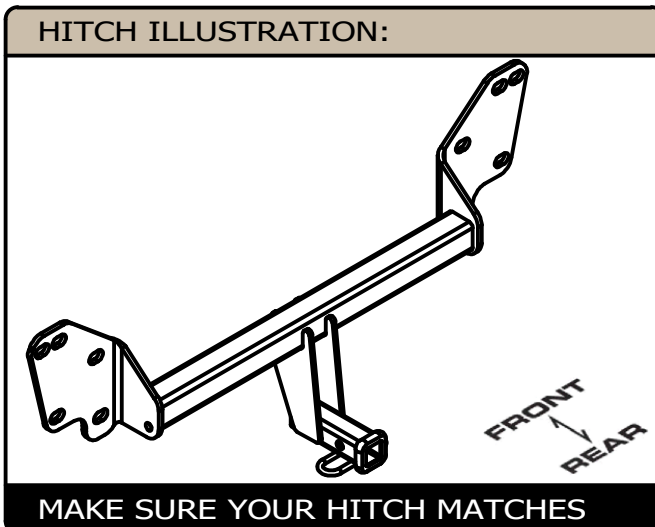

SCAN FOR MORE INFO

PERIODICALLY CHECK THIS RECEIVER HITCH TO ENSURE ALL FASTENERS ARE TIGHT AND ALL STRUCTURAL COMPONENTS ARE SOUND

CURT Manufacturing LLC. warrants this product to be free of defects in material and/or workmanship at the time of retail purchase by the original purchaser. If the product is found to be defective, CURT Manufacturing LLC. may repair or replace the product at their option, when the product is returned, prepaid, with proof of purchase. Alteration to, misuse of, or improper installation of this product voids the warranty. CURT Manufacturing LLC.'s liability is limited to repair or replacement of products found to be defective, and specifically excludes liability for incidental or consequential loss or damage.

For more information log onto www.curtmfg.com

This product complies with safety specifications and requirements for connecting devices and towing systems of the state of New York, V.E.S.C.Regulation V-5 and SAE J684.

INSTALLATION WALKTHROUGH:

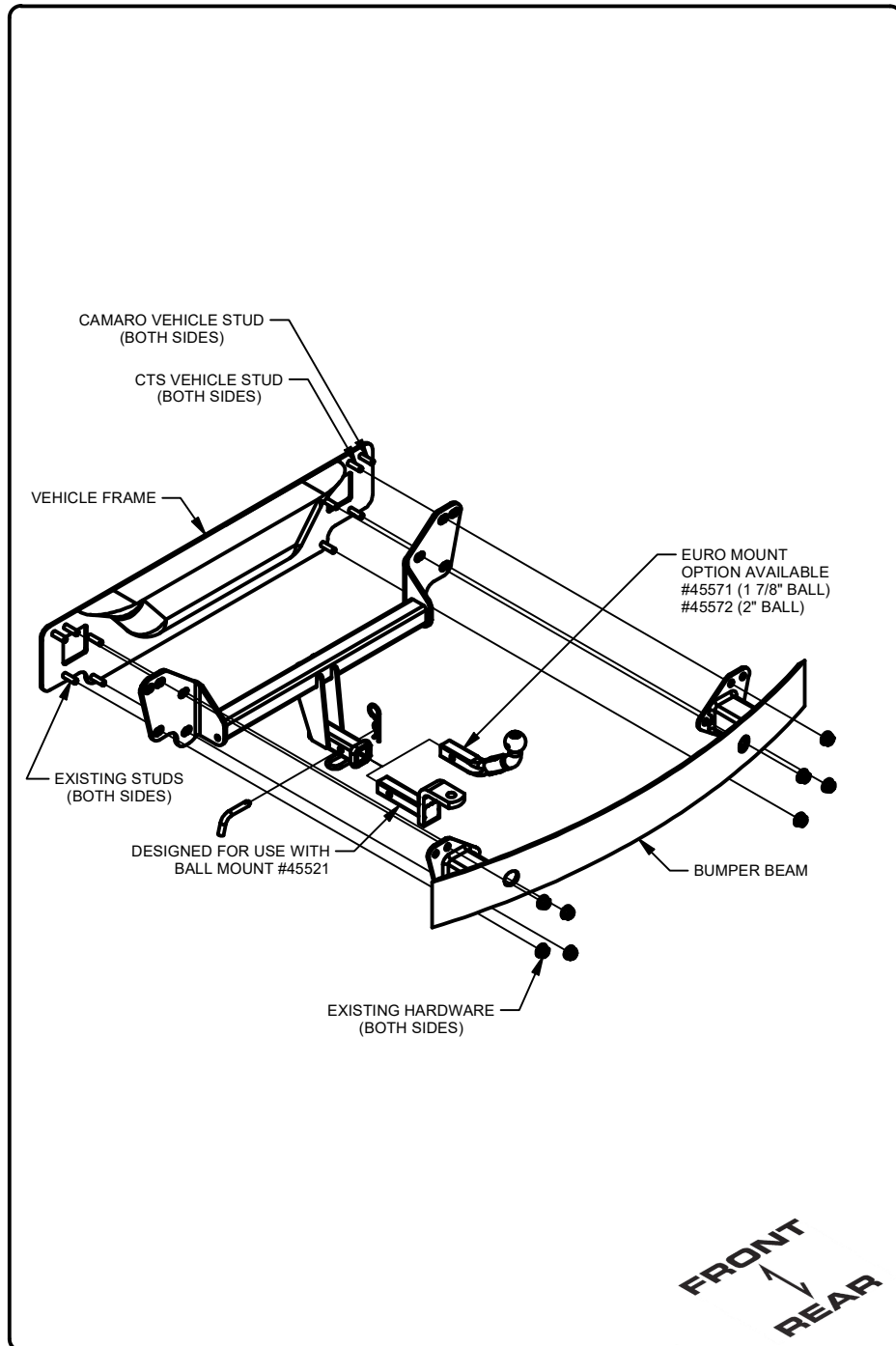

For more information log onto www.curtmfg.com

1. Remove (4) T15 screws along wheel well (2) on each side using T15 Torxbit Socket.

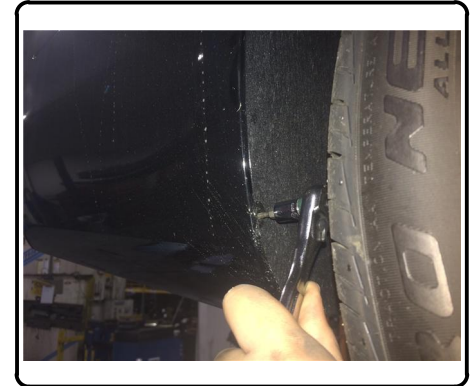

2. Remove (12) M4 screws on the bottom of the bumper fascia using 7mm socket.

NOTE: CTS-V models need to remove (4) T20 Torxbit screws connecting the heat shield to the fascia.



INSTALLATION WALKTHROUGH:

3. Pull back wheel well cover to remove (2) M4 screws using 7mm socket (1) on each side.

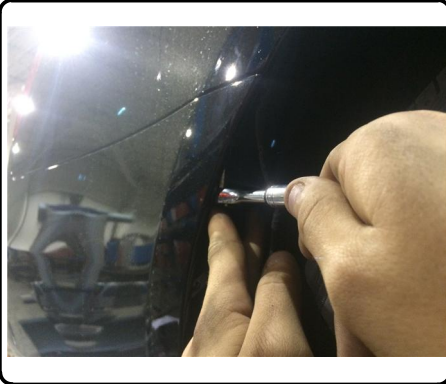

4. Inside the trunk along the plastic liner guard use plastic pry bar to remove (2) caps, (1) on each side, to access and remove (2) T45 bolts, (1) on each side using T45 Torxbit Socket.
NOTE: To remove trunk liner on Camaro models remove (4) plastic wing nuts located inside of the trunk.

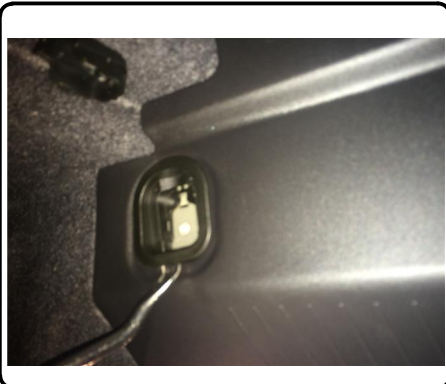

5. Gently remove plastic trunk liner guard and set aside for reinstallation in step 12. Inside the trunk use plastic pry bar to remove (4) plastic clips, (2) on each side, to access taillight removal.
NOTE: To access taillight on Camaro models remove (4) plastic clips (2) on each side.

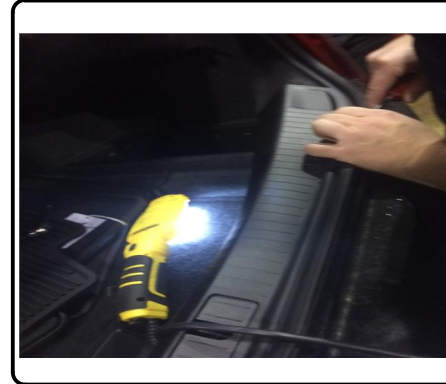

6. To remove taillights, locate and remove (8) M5 nuts using 8mm socket, (4) on each side. Unclip electrical harness and gently remove taillight, set aside for reinstallation in step 12.

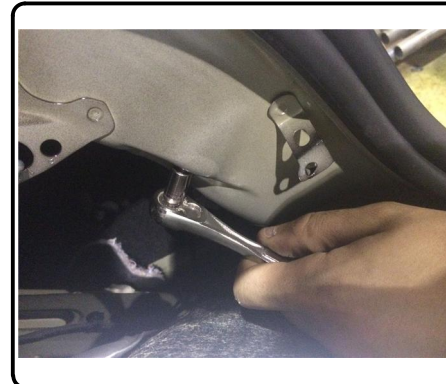

INSTALLATION WALKTHROUGH:

7. Gently remove rear bumper fascia by releasing the press-in tabs along top portion of bumper fascia. Unclip motion sensor harness on the driver side of vehicle. Set aside for reinstallation in step 12.



8. Remove the bumper beam by removing (8) M10 nuts using 15mm socket, (4 on each side). Set aside bumper beam for reinstallation in step 12.

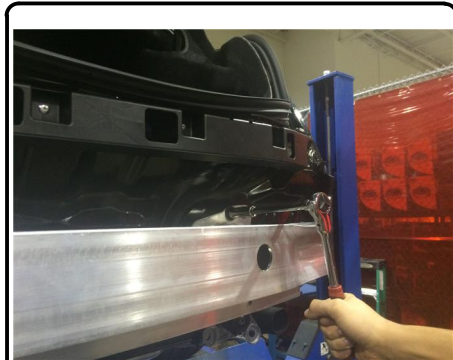

9. Install hitch on rear of vehicle frame using existing studs. Reinstall bumper beam over hitch. Loosely secure with M10 hardware.

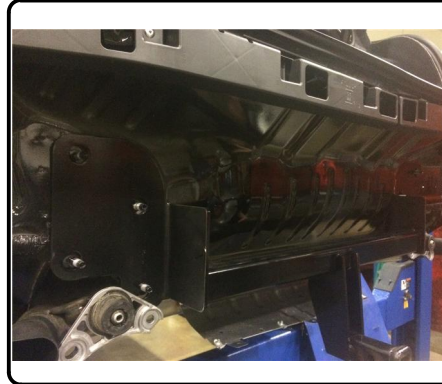

10. Torque all M10 hardware to 45 ft-lbs.

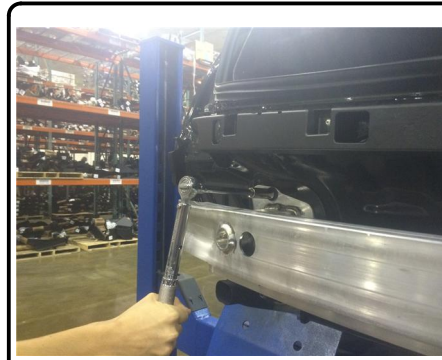

INSTALLATION WALKTHROUGH:

11. Trim bumper fascia as shown in the trim diagram using aviation shears.

CTS NOTE: Approximate cut out dimension, 2.50" x 5.00", should be centered with the bumper fascia.

Camaro NOTE: Approximate cut out dimension, 2.50" x 3.00", should be centered with the bumper fascia.



CTS BUMPER FASCIA TRIM DETAIL

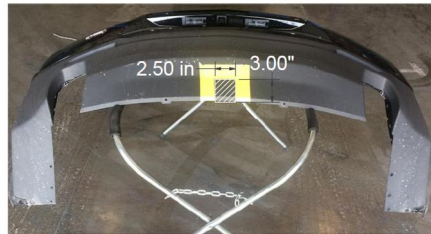

CAMARO BUMPER FASCIA TRIM DETAIL

12. Reinstall rear bumper fascia removed in step 7. Reinstall taillights removed in step 6. Reinstall trunk liner guard removed in step 5. Reinstall all fasteners removed in steps 1-4 in reverse order.

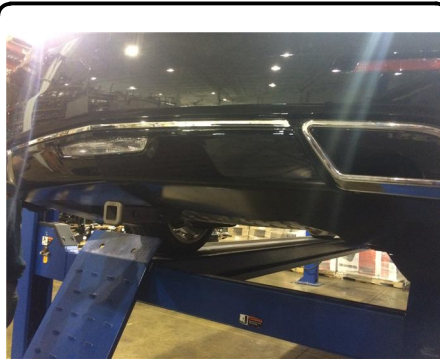

13. Installation complete.

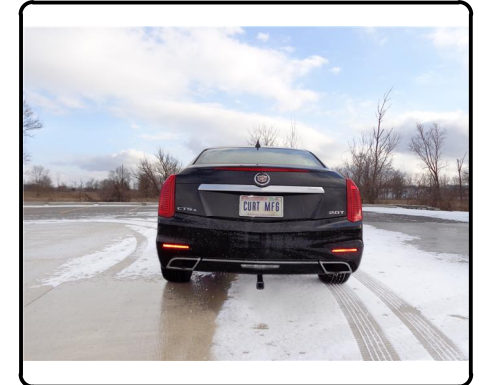

TOWING SAFETY INFORMATION

Gross Trailer Weight / GTW

The Gross Trailer Weight is the weight of the trailer & cargo. Measure this by putting the fully loaded trailer on a vehicle scale.

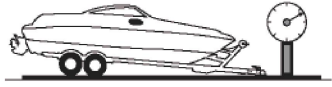

Tongue Weight / TW

The downward force that is exerted on the hitch ball by the coupler. The tongue weight will vary depending on where the load is positioned in relationship to the trailer axle(s). To measure the tongue weight, use either a commercial scale or a bathroom scale with the coupler at towing height. When using a bathroom scale with heavier tongue weights, use the method shown and multiply the scale reading by 3.

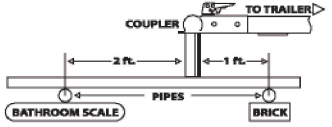

Weight Carrying / WC

The total weight of both the trailer and the cargo inside. Never exceed the weight capacity of your trailer hitch.

Weight Distribution / WD

Used to balance the weight of the cargo between the front and rear wheels throughout the trailer, allowing for better steering, braking, and level riding.



Sway Control

A device used to reduce the lateral movements of the trailer that are caused by the wind. This works in conjunction with a weight distribution hitch. Do not use this on a class 1 or 2 hitch, or with surge brakes.

How Much Can You Safely Tow?

TONGUE WEIGHT lbs	1000	2000	3000	4000	5000	6000	7000	8000	10,000	12,000
Tongue weight should be about 10 to 15 percent of the gross trailer weight.										
CLASS 1										
CLASS 2										
CLASS 3										
CLASS 4										
CLASS 5										
Camper	11'	12'	13'	14'	15'	16'				
lbs	1100	1200	1300	1400	1500	1600				
Vacation	14'	16'	18'	20'	22'	24'	26'	28'	30'	32'
lbs	2100	2400	2700	3000	3300	3600	3900	4200	4500	4800
Vacation	14'	16'	18'	20'	22'	24'	26'	28'	30'	32'
lbs	2800	3200	3600	4000	4400	4800	5200	5600	6000	6400
5th Wheel										

Refer to owner's manual for towing capabilities and limitations.

Ball Mount

The ball mount is placed inside the opening of the receiver hitch which is mounted to the vehicle. Make sure a hitch pin and clip is properly securing the ball mount to the receiver hitch before you begin towing.

- A: Rise. B: Drop. C: Hole Size. D: Length.

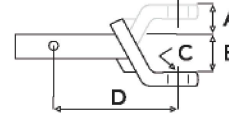

Trailer Ball

The connection from the hitch to the trailer. There are many factors that determine the correct hitch ball:

- Number one is the hitch ball's gross trailer weight rating.
- The mounting platform must be at least 3/8" thick.
- The hole diameter must not be more than 1/16" larger than the threaded shank.
- Every time you tow, check the nut and lock washer to make sure they are fastened securely.
- A: Ball Dia. B: Shank Dia. C: Shank Length. D: Shank Rise.

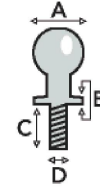

Coupler

The component that is placed over the trailer ball to connect the vehicle to the trailer. Be sure that the coupler size matches the size of the hitch ball and that the coupler handle is securely fastened. To determine what size hitch ball you need for your application you will need to know the size of coupler that is on the trailer. Be sure your coupler is properly adjusted to the ball you are using.

NOTE: For added security the use of safety devices such as Coupler Safety Pins and Locks is strongly recommended.

Safety Chains

Safety chains are a requirement and should be crossed under the tongue of the trailer so that the tongue will not drop to the road if it becomes separated from the hitch. Always leave enough slack so you can turn. Never allow the safety chains to drag on the ground and never attach the chains to the bumper.

Trailer Classification: Safety Chain Breaking Force - Minimum

- Class 1: 2,000 lbs. (8.9 kN)
- Class 2: 3,500 lbs. (15.6 kN)
- Class 3: 5,000 lbs. (22.2 kN)

The strength rating of each length of safety chain or its equivalent and its attachments shall be equal to or exceed in minimum breaking force the GVWR (Gross Vehicle Weight Rating) of the trailer.

Electrical

Trailer lights, Electric Brakes, Break-away systems - Every time you tow, be sure to check that all components are working properly.

Wiring identification by color:

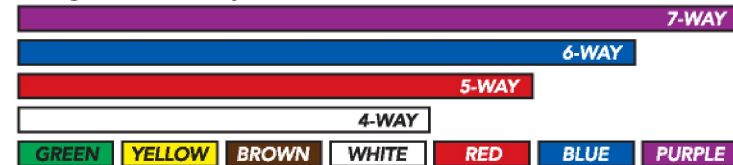

11900

CADILLAC CTS(V) / CHEVROLET CAMARO

10/28/2020

GROSS LOAD CAPACITY WHEN USED AS A WEIGHT CARRYING HITCH: 2,000 LBS. TRAILER WEIGHT & 200 LBS. TONGUE WEIGHT.



WARNING: * DO NOT EXCEED VEHICLE MANUFACTURER'S RECOMMENDED TOWING CAPACITY. *****

FOR MORE INFORMATION LOG ONTO WWW.CURTMFG.COM & FOR HELPFUL TOWING TIPS LOG ONTO WWW.HITCHINFO.COM
HAVING INSTALLATION QUESTIONS? CALL TECHNICAL SUPPORT AT 877-287-8634

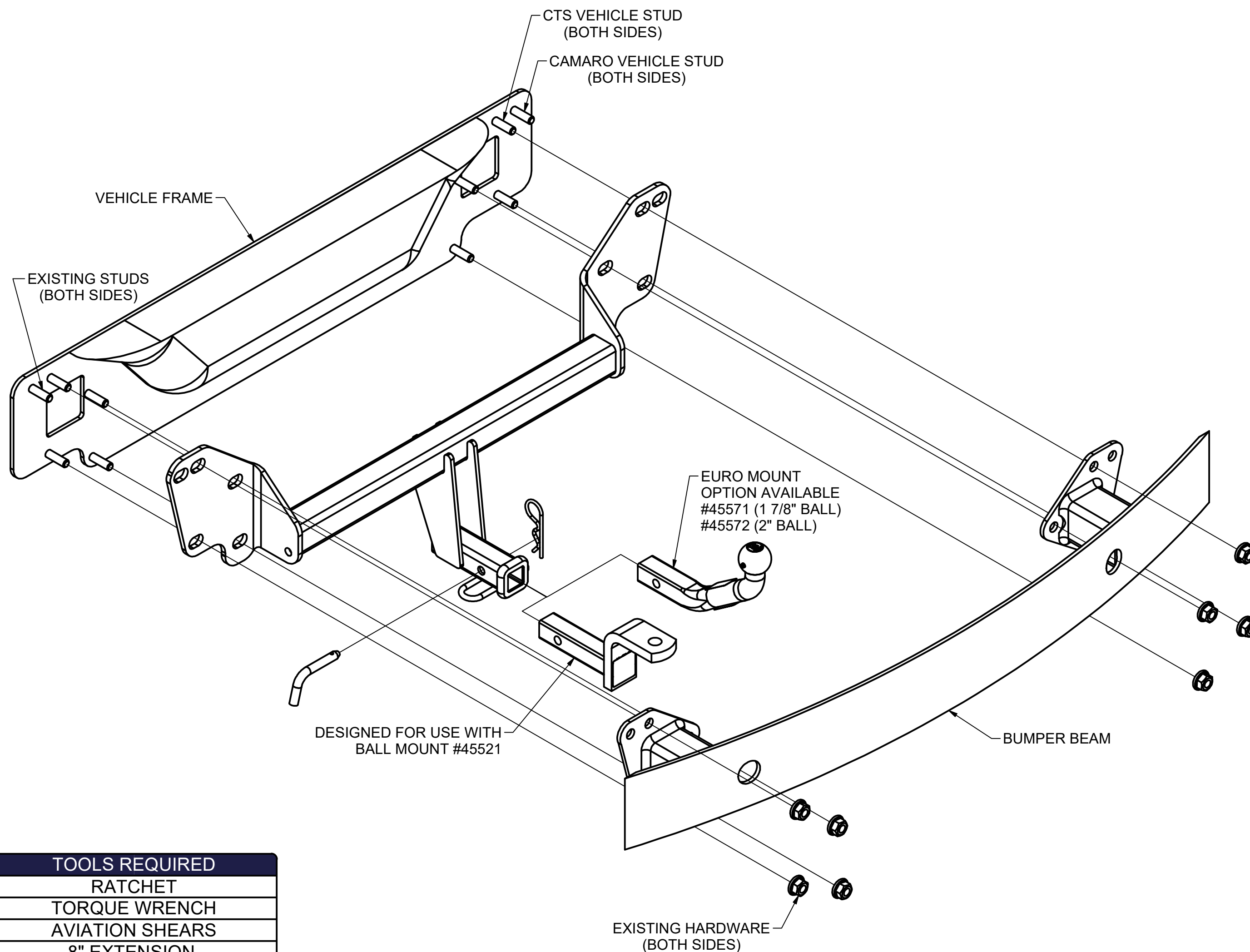

TOOLS REQUIRED
RATCHET
TORQUE WRENCH
AVIATION SHEARS
8" EXTENSION
T15 TORXBIT SOCKET
T20 TORXBIT SOCKET
T45 TORXBIT SOCKET
7mm SOCKET
8mm SOCKET
15mm SOCKET
PLASTIC PRY BAR

HITCH WEIGHT: 27 LBS.

INSTALL TIME

PROFESSIONAL: 45 MINUTES

NOVICE (DIY): 90 MINUTES

INSTALL NOTES:

- NO DRILLING REQUIRED
- USE EXISTING HARDWARE
- BUMPER FASCIA REMOVAL
- BUMPER FASCIA TRIM

FRONT
↑
REAR

PERIODICALLY CHECK THIS RECEIVER HITCH TO ENSURE THAT ALL FASTENERS ARE TIGHT AND THAT ALL STRUCTURAL COMPONENTS ARE SOUND.



Scan for more information

CURT Manufacturing LLC., warrants this product to be free of defects in material and/or workmanship at the time of retail purchase by the original purchaser. If the product is found to be defective, CURT Manufacturing LLC., may repair or replace the product, at their option, when the product is returned, prepaid, with proof of purchase. Alteration to, misuse of, or improper installation of this product voids the warranty. CURT Manufacturing LLC.'s liability is limited to repair or replacement of products found to be defective, and specifically excludes liability for incidental or consequential loss or damage.

This product complies with safety specifications and requirements for connecting devices and towing systems of the state of New York, V.E.S.C.Regulation V-5 and SAE J684.



CTS BUMPER FASCIA TRIM DETAIL

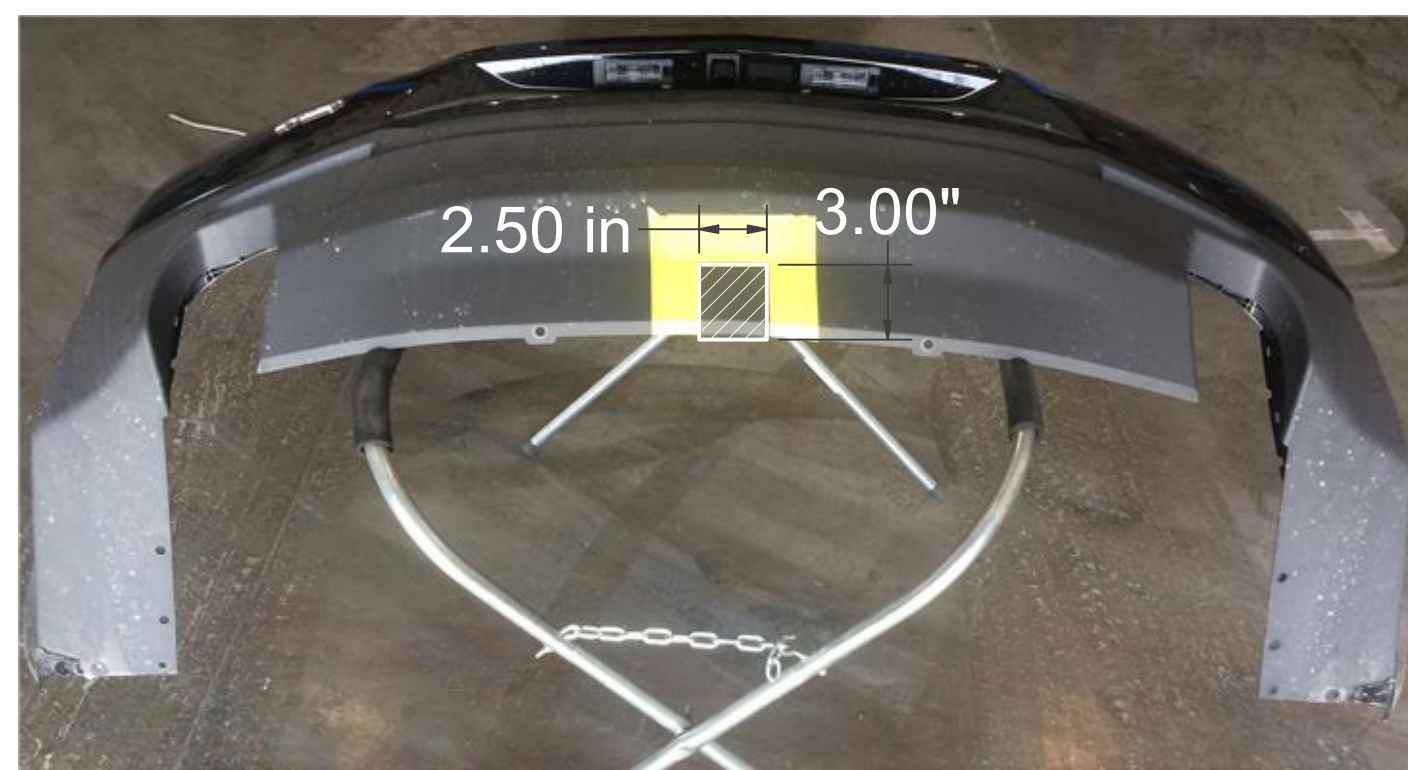

CAMARO BUMPER FASCIA TRIM DETAIL

INSTALLATION STEPS

1. Remove (4) T15 screws along the wheel well (2) on each side using T15 Torxbit socket.
2. Remove (12) M4 screws on the bottom of the bumper fascia using 7mm socket.
NOTE: CTS-V models need to remove (4) T20 Torxbit screws connecting the heat shield to the fascia.
3. Pull back wheel well cover to remove (2) M4 screws using 7mm socket (1) on each side.
4. Inside the trunk along the plastic liner guard use plastic pry bar to remove (2) caps, (1) on each side, to access and remove (2) T45 bolts, (1) on each side, using T45 Torxbit Socket.
NOTE: To remove trunk liner in Camaro models remove (4) plastic wing nuts located inside of the trunk.
5. Gently remove plastic trunk liner guard and set aside for reinstallation in step 12. Inside the trunk use plastic pry bar to remove (4) plastic clips, (2) on each side, to access taillight removal.
NOTE: To access taillight on Camaro models remove (4) plastic clips (2) on each side located directly above taillight.
6. To remove taillights, locate and remove (8) M5 nuts using 8mm socket, (4) on each side. Unclip electrical harness and gently remove taillight, set aside for reinstallation in step 12.
7. Gently remove rear bumper fascia by releasing the press-in tabs along top portion of bumper fascia. Unclip motion sensor harness on the driver side of vehicle. Set aside for reinstallation in step 12.
8. Remove the bumper beam by removing (8) M10 nuts using 15mm socket, (4) on each side. Set aside bumper beam for reinstallation in step 12.
9. Install hitch on rear of vehicle frame using existing studs. Reinstall bumper beam over hitch. Loosely secure with M10 hardware.
10. Torque all M10 hardware to 45 ft-lbs.
11. Trim bumper fascia as shown in the trim diagram using aviation shears.
12. Reinstall rear bumper fascia removed in step 7. Reinstall taillights removed in step 6. Reinstall trunk liner guard removed in step 5. Reinstall all fasteners removed in steps 1-4 in reverse order.
13. Installation complete.

PERIODICALLY CHECK THIS RECEIVER HITCH TO ENSURE THAT ALL FASTENERS ARE TIGHT AND THAT ALL STRUCTURAL COMPONENTS ARE SOUND.