



Safety glasses should be worn at all times while installing this product.

YEARS: 2014-PRESENT

MAKE: JEEP

MODEL: CHEROKEE

STYLE: ALL (INCLUDES TRAILHAWK)

WARNING: NEVER EXCEED YOUR VEHICLE MANUFACTURER'S RECOMMENDED TOWING CAPACITY





WEIGHT CARRYING:
 TRAILER WEIGHT: 5000 LBS.
 TONGUE WEIGHT: 750 LBS.

WEIGHT DISTRIBUTION:
 TRAILER WEIGHT: 6000 LBS.
 TONGUE WEIGHT: 750 LBS.

PRO INSTALL TIME: 30 MIN.
NOVICE INSTALL TIME: 60 MIN.

IF YOU ARE HESITANT TO UNDERTAKE THIS TASK ON YOUR OWN, CONTACT AN AUTHORIZED CURT INSTALLER FOR ADDITIONAL ASSISTANCE.



INSTALLATION REQUIRES:

 SAFETY GLASSES	 RATCHET	 3/4" 8mm 21mm SOCKET
 6" SOCKET EXTENSION	 TORQUE WRENCH	

INSTALLATION TIPS:

- BEFORE YOU BEGIN INSTALLATION, READ ALL INSTRUCTIONS THOROUGHLY.
- TO EASE INSTALLATION, 2 PEOPLE MAY BE REQUIRED.
- USING PROPER TOOLS WILL GREATLY IMPROVE THE QUALITY OF THE INSTALL AND REDUCE THE TIME REQUIRED.
- NEED HELP OR HAVE SOME QUESTIONS? CALL TECHNICAL SUPPORT AT 800.798.0813

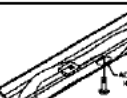
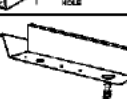
LEVEL OF DIFFICULTY: EASY

EASY	MODERATE	CHALLENGING
	NO DRILLING REQUIRED	
	FISHWIRE HARDWARE	
	REVERSE FISHWIRE HARDWARE	
	TRAILHAWK MODELS: CLEAN WELDNUTS IF NEEDED	
	TRAILHAWK MODELS: TEMPORARILY REMOVE PLASTIC FASCIA	

VEHICLE PHOTO:



REPRESENTATIVE PHOTO

HITCH ILLUSTRATION:

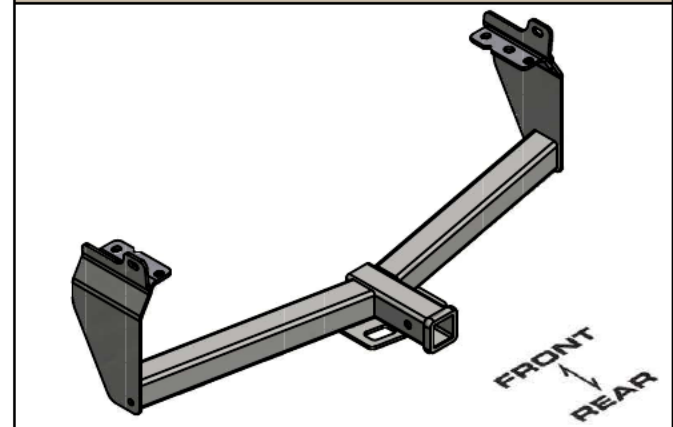

MAKE SURE YOUR HITCH MATCHES



SCAN FOR MORE INFO

PERIODICALLY CHECK THIS RECEIVER HITCH TO ENSURE ALL FASTENERS ARE TIGHT AND ALL STRUCTURAL COMPONENTS ARE SOUND CURT Manufacturing LLC. warrants this product to be free of defects in material and/or workmanship at the time of retail purchase by the original purchaser. If the product is found to be defective, Curt Manufacturing LLC. may repair or replace the product at their option, when the product is returned, prepaid, with proof of purchase. Alteration to, misuse of, or improper installation of this product voids the warranty. Curt Manufacturing LLC.'s liability is limited to repair or replacement of products found to be defective, and specifically excludes liability for incidental or consequential loss or damage. For more information

INSTALLATION WALKTHROUGH:

Parts List			
ITEM	QTY	PART NUMBER	DESCRIPTION
1	6	20-00062	NUT,SER-FLANGE,1/2-13 UNC,GRD8,YZ
2	6	10-10287	BOLT,CAR,1/2-13 UNC,1-1/2,GRD8,YZ
3	6	1_2 FIS HWIRE	1/2" FIS HWIRE
4	6	CM-SP 6	.250 x 1.00 x 3.00" SQUARE HOLE SPACER

FISHWIRE TECHNIQUE
 INSERT COILED END OF FISHWIRE TOOL THROUGH HITCH MOUNTING HOLE IN VEHICLE FRAME RAIL AND OUT THE ACCESS HOLE. PASS COILED END OF FISHWIRE THROUGH SPACER AND THREAD BOLT INTO COIL. KINK WIRE TO KEEP SPACER SEPERATE FROM BOLT AS SHOWN. PULL FISHWIRE, SPACER, AND BOLT THROUGH FRAME AND OUT MOUNTING HOLE. USE FISHWIRE TO GUIDE HITCH DURING MOUNTING AND PREVENT LOSS OF BOLT / SPACER INSIDE FRAME RAIL.
"NOTE: SOME VEHICLES MAY FISHWIRE THROUGH END OF FRAME"

REVERSE PULL FISHWIRE TECHNIQUE
 ATTACH FISHWIRE TO CARRIAGE BOLT AND SLIDE SPACER ONTO FISHWIRE. PUSH THE BOLT THRU THE HOLE FOLLOWED BY THE SPACER (AS SHOWN). PULL BOLT BACK INTO POSITION, PROTRUDING FROM THE FRAME.

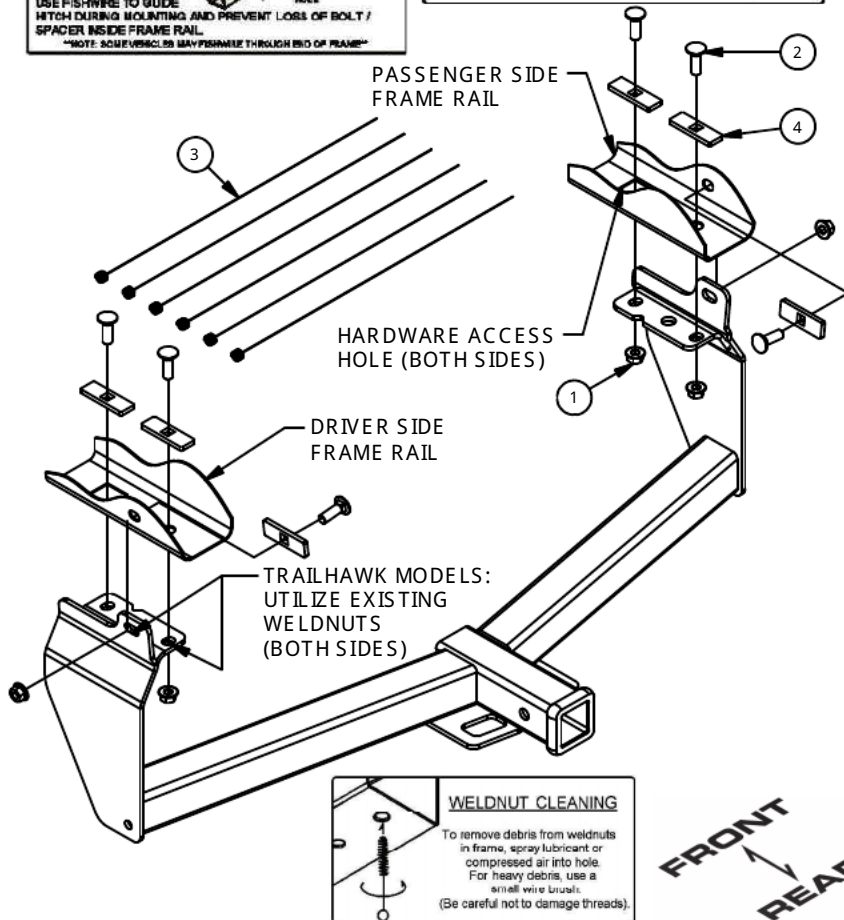

1. Trailhawk models: Temporary plastic fascia removal is required for install. Remove (4) screws with a 10mm socket from the bottom of the panel, and push on tabs to unclip. Set aside for reassembly.

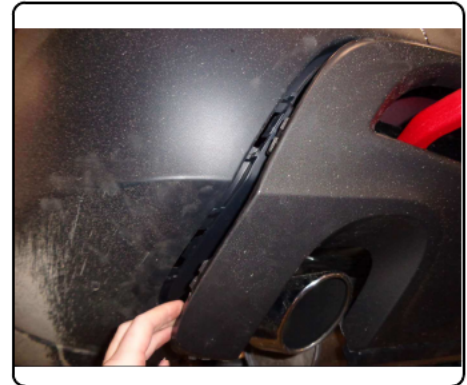

2. Examine vehicle frame rails - If wire is present on either side frame rail, unfasten by pulling retainer out of the frame and temporary let hang loose below frame rail.
 Remove square rubber plug on each side of the frame rail to expose hardware access holes. Return plugs to owner.

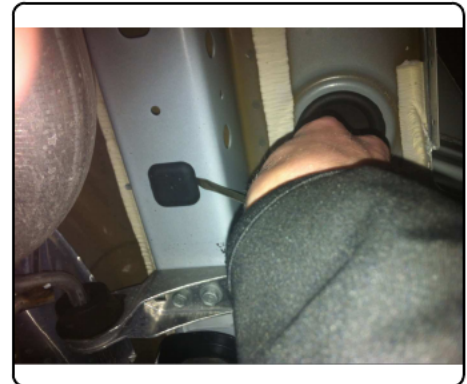
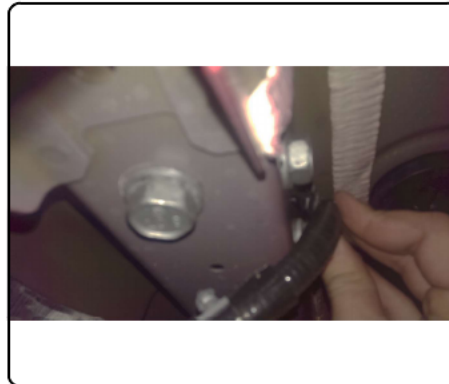

INSTALLATION WALKTHROUGH:

3. Fishwire rear and side mounting hole hardware through the access hole in the vehicle frame. Reverse fishwire remaining hardware through the access hole (both sides).
Trailhawk models: Only use "reverse fishwire hardware" and the vehicle M14 bolts previously removed.

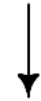
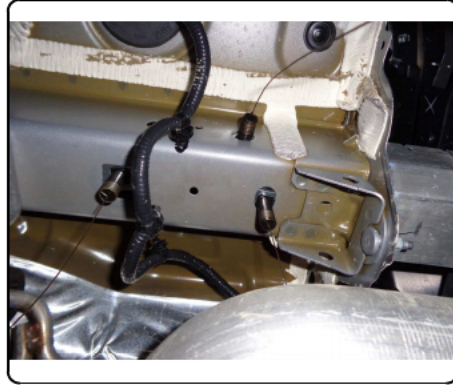

4. Raise hitch up from in front of the exhaust and into position, using care not to push hardware back inside frame. Be sure to loosely secure hitch with the mounting hardware to align all holes before tightening.
Note: Seam foam may need to be trimmed for proper mounting plate fit.

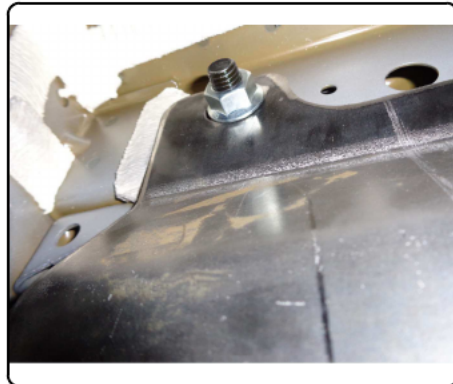
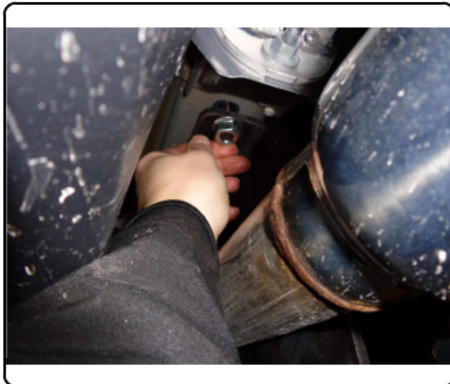

5. As needed, resecure wire to vehicle frame rail.

Torque all 1/2" hardware to 110 lb-ft.
Trailhawk: Torque all M14 hardware to 139 lb-ft.

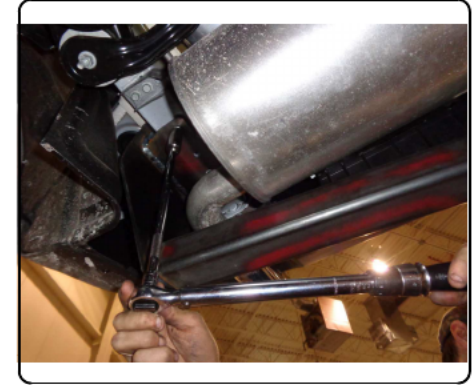
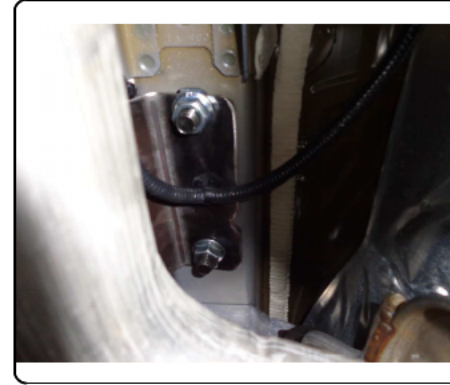

6. Trailhawk models: Clip plastic fascia panels into place and secure with (4) screws.

Installation Complete



13171 JEEP CHEROKEE (ALL MODELS INCLUDING TRAILHAWK)

5/15/2020

GROSS LOAD CAPACITY WHEN USED AS A WEIGHT CARRYING HITCH: 5,000 LBS. TRAILER WEIGHT & 750 LBS. TONGUE WEIGHT.
GROSS LOAD CAPACITY WHEN USED AS A WEIGHT DISTRIBUTION HITCH: 6,000 LBS. TRAILER WEIGHT & 750 LBS. TONGUE WEIGHT

DO NOT EXCEED VEHICLE MANUFACTURER'S RECOMMENDED TOWING CAPACITY.

HAVING INSTALLATION QUESTIONS? CALL TECHNICAL SUPPORT AT 1-877-287-8634

Parts List			
ITEM	QTY	PART NUMBER	DESCRIPTION
1	6	20-00062	NUT, SER-FLANGE, 1/2-13 UNC, GRD8, YZ
2	6	10-10287	BOLT, CAR, 1/2-13 UNC, 1-1/2, GRD8, YZ
3	6	1_2 FIS HWIRE	1/2" FIS HWIRE
4	6	CM-SP6	.250 x 1.00 x 3.00" SQUARE HOLE SPACER

RATCHET	
3/4", 8mm, 21mm SOCKET	
6" SOCKET EXTENSION	
TORQUE WRENCH	

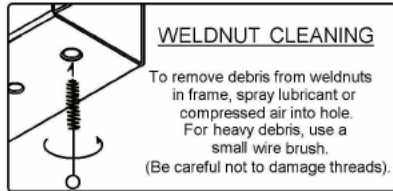
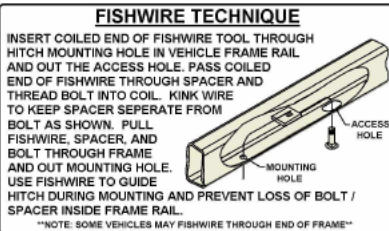
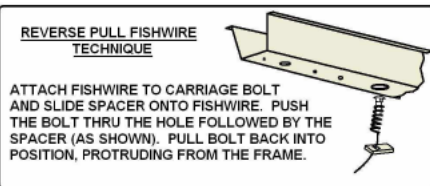

HITCH WEIGHT: 48 LBS.
INSTALL TIME
PROFESSIONAL: 30 MINUTES
NOVICE (DIY): 60 MINUTES
INSTALL NOTES:
- NO DRILLING
- FISHWIRE HARDWARE
- REVERSE FISHWIRE HARDWARE
- TRAILHAWK: TEMP. REMOVE FASCIA

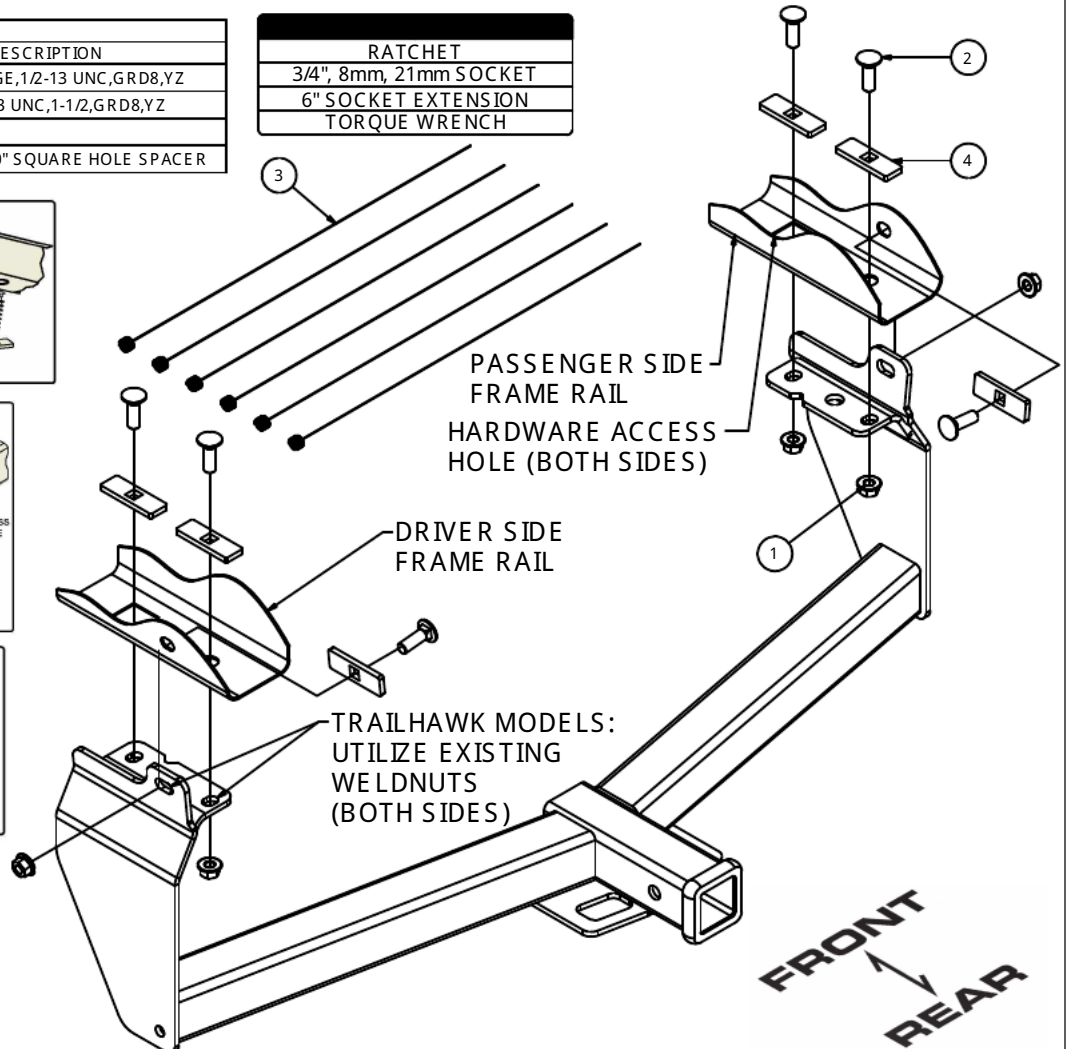

INSTALLATION STEPS

- Trailhawk models: Temporary plastic fascia removal is required for install. Remove (4) screws with a 10mm socket from the bottom of the panel, and push on tabs to unclip. Set aside for reassembly.
- Examine vehicle frame rails - If wire is present on either side frame rail, unfasten by pulling retainer out of the frame and temporarily let hang loose below frame rail. Remove square rubber plug on each side of the frame rails to expose access holes. Return plugs to owner.
- Fishwire rear and side mounting hole hardware through the access hole in the vehicle frame. Reverse fishwire remaining hardware through the access hole (both sides). Trailhawk models: Only use "reverse fishwire hardware" and the vehicle M14 bolts previously removed.
- Raise hitch up from in front of the exhaust and into position, using care not to push hardware back inside frame. Be sure to loosely secure hitch with the mounting hardware to align all holes before tightening. Note: Seam foam may need to be trimmed for proper mounting plate fit.
- As needed, resecure wire to vehicle frame rail. Torque all 1/2" hardware to 110 lb-ft. Trailhawk models: Torque all M14 hardware to 139 lb-ft.
- Trailhawk models: Clip plastic fascia panel into place and secure with (4) screws.

PERIODICALLY CHECK THIS RECEIVER HITCH TO ENSURE THAT ALL FASTENERS ARE TIGHT AND THAT ALL STRUCTURAL COMPONENTS ARE SOUND.



Scan for more information

Curt Manufacturing LLC., warrants this product to be free of defects in material and/or workmanship at the time of retail purchase by the original purchaser. If the product is found to be defective, Curt Manufacturing LLC., may repair or replace the product, at their option, when the product is returned, prepaid, with proof of purchase. Alteration to, misuse of, or improper installation of this product voids the warranty. Curt Manufacturing LLC.'s liability is limited to repair or replacement of products found to be defective, and specifically excludes liability for incidental or consequential loss or damage.