

INSTALLATION INSTRUCTIONS

WARNING: NEVER EXCEED YOUR VEHICLE MANUFACTURER'S RECOMMENDED TOWING CAPACITY

FIXED, HITCH-MOUNTED, BASKET-STYLE CARGO CARRIER



PARTS LIST

Item#	Qty	Description
1	2	Frame half
2	1	Shank, 2"
3	2	Connecting plate
4	2	Locknut, M12
5	2	Flat washer, M12
6	2	Carriage bolt, M12*75
7	8	Locknut, M10
8	8	Flat washer, M10
9	8	Carriage bolt, M10*20

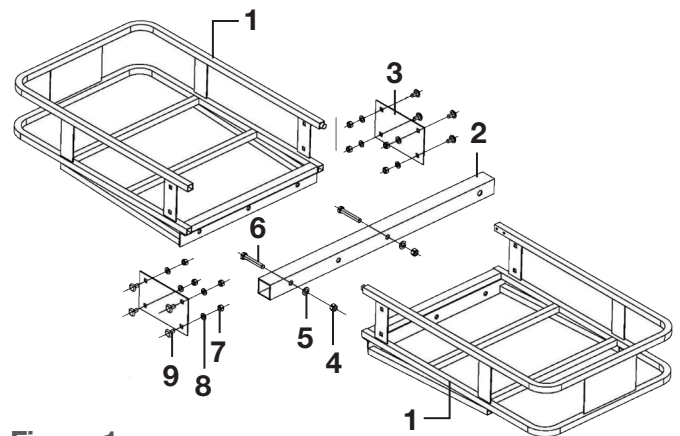

Figure 1

SUGGESTED TOOLS

Open wrench, 17mm and 19mm



Adjustable wrench, 0 to 30mm



WARNINGS

Do not exceed maximum weight capacity of 500 lbs. when using 2" receiver tube. Distribute the weight evenly on platform when hauling a load. **NOTE:** This carrier is not intended for transporting people.

Do not carry loads wider or deeper than carrier. Do not carry flammable items on carrier. Do not allow exhaust fumes to blow directly on items. This is a fire hazard.

CURT Manufacturing, LLC is not responsible for any damage if warnings are not heeded.

ASSEMBLY

Step 1

Align the two platform halves (#1) on either side of the 2" shank (#2). Insert the two M12*75 carriage bolts (#6) through the frame (#1), shank (#2) and other frame half (#1). Install M12 flat washers (#5) and M12 locknuts (#4) on the bolts (#6). Tighten to 80% only.

Step 2

Place the two connecting plates (#3) onto the front and back of the frames (#1). Install M10 bolts (#9) through the outside of the frames (#1). Add the M10 flat washers (#8) and tighten with M10 locknuts (#7) to the inside of the frames (#1).

Step 3

Fully tighten all of the bolts and locknuts.

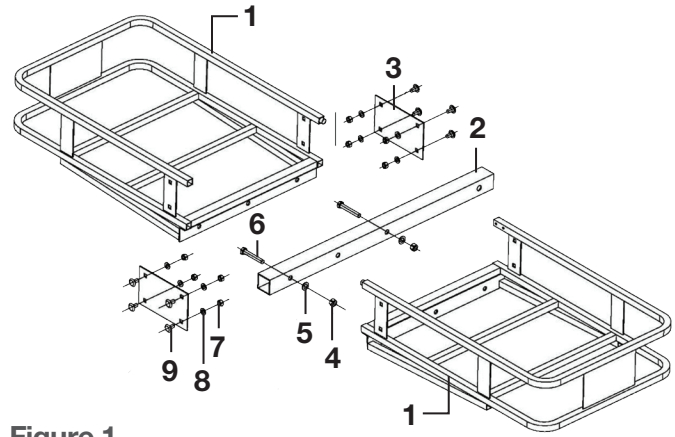

Figure 1