

INSTALLATION INSTRUCTIONS



XTS BRUSH GUARD

APPLICATION:

2021 - 2023 Ford Bronco (Excl. Bronco Sport) W/ OEM Steel Bumper

PART NUMBER:

59-751255

CONTENT			
ITEM	QUANTITY	DESCRIPTION	TOOLS NEEDED
1	2	LIGHT CHANNEL	13MM SOCKET
2	1	DRIVER WING	13MM WRENCH
3	1	PASSENGER WING	13MM RATCHET
4	1	DRIVER SIDE LOWER SUPPORT BRACKET	ALLEN KEY
5	1	PASSENGER SIDE LOWER SUPPORT BRACKET	TORQUE WRENCH
6	1	DRIVER FRAME SUPPORT BRACKET	
7	1	PASSENGER FRAME SUPPORT BRACKET	
8	8	M8 HEX HEAD CAP SCREW	
9	10	M8 SPLIT LOCK WASHER	
10	8	M8 FLAT WASHER (SMALL)	
11	2	M8 BUTTON HEAD BOLT	
12	2	M8 FLAT WASHER (BIG)	

ANTI-SEIZE LUBRICANT MUST BE USED ON ALL STAINLESS STEEL FASTENERS TO PREVENT THREAD DAMAGE AND GALLING

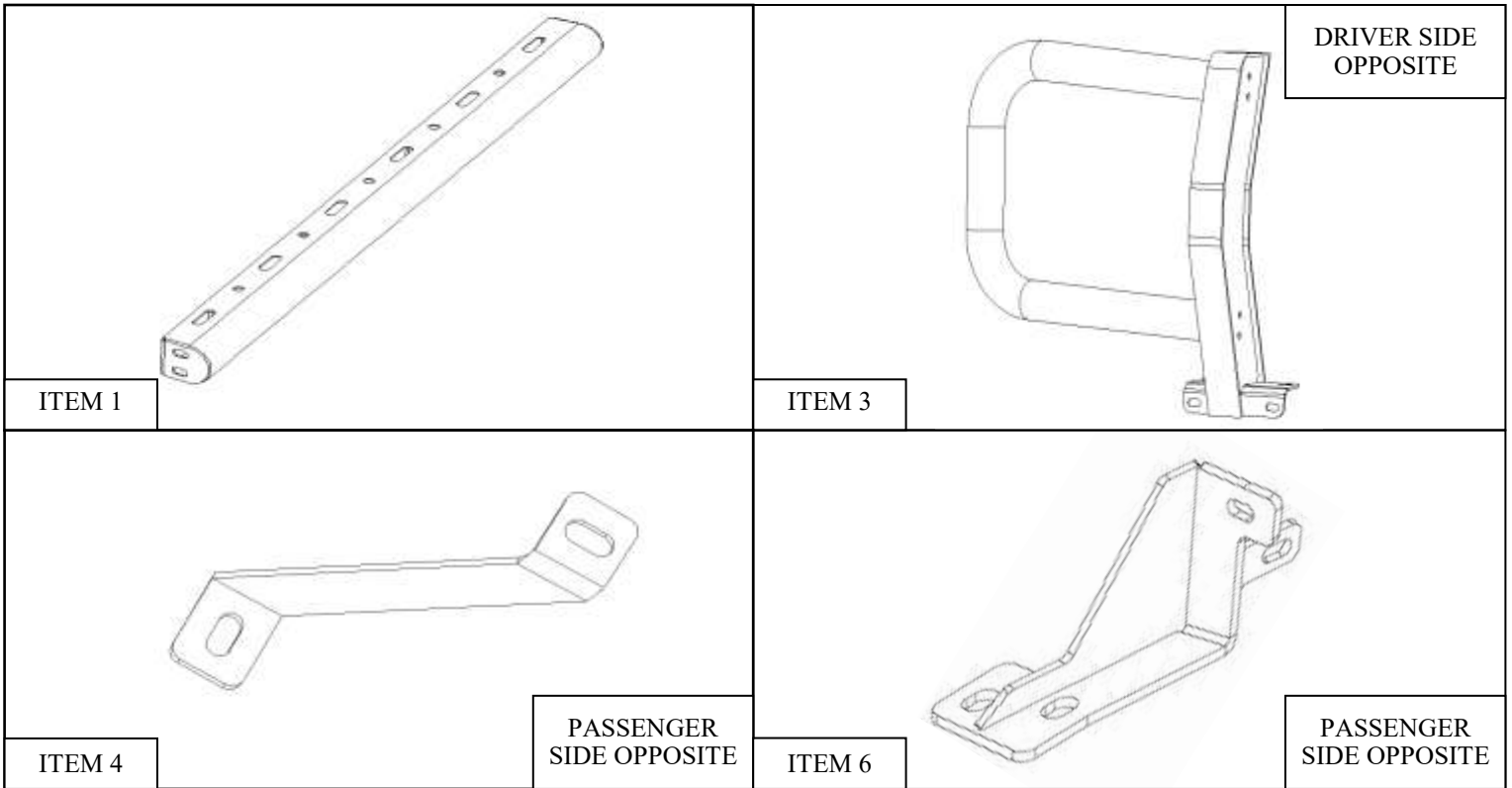

PROCEDURE

1. Remove contents from box, verify if all parts listed are present and free from damage.
Carefully read and understand all instructions before attempting installation.
Failure to identify damage before installation could lead to a rejection of any claim.
2. Begin by assembling the Light Channels (**Item 1**) to the Driver Side Wing (**Item 2**) using the provided M8 hardware (**Items 8-10**). See **Figure 1 and 2** for reference. *Note: If you are installing any kind of lights onto the Brush Guard, make sure the light mounting locations face in the direction you would like the lights to face once they are installed. If no lights are being installed, it is recommended that light channels are installed with mounting locations facing downwards for a smoother look.*
3. Repeat **Step 2** for the Passenger Side Wing (**Item 3**).

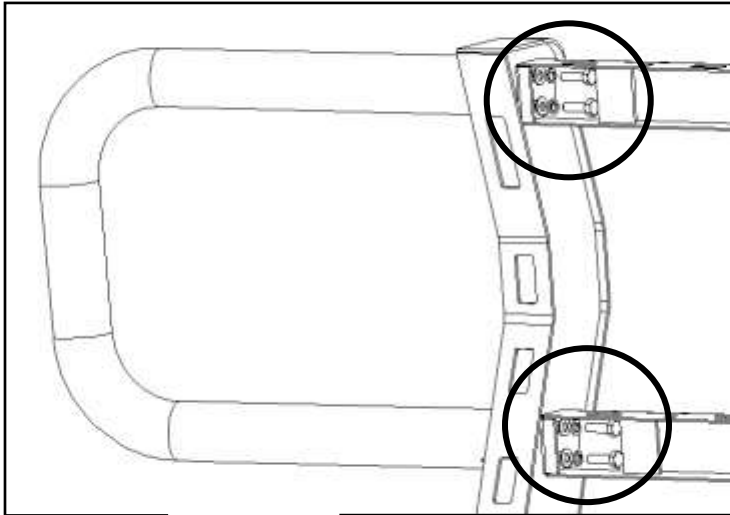

Figure 1

Driver Side Wing Shown

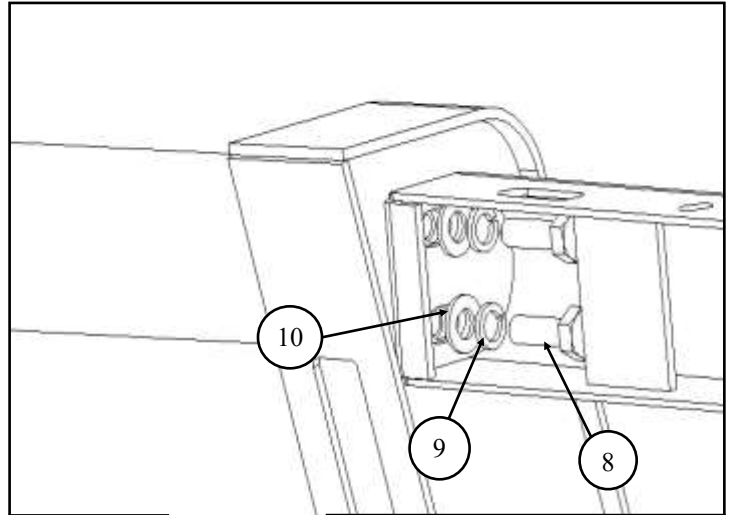

Figure 2

Driver Side Wing Shown

3. Remove the bolts shown from each side of the factory bumper. Save these bolts as they will be used to attach the Brush Guard assembly. See **Figure 3** for reference.
4. Remove the bolts shown from each side of the factory bumper. Save these bolts as they will be used to attach the Lower Support Brackets (**Items 4 & 5**). See **Figure 4** for reference.



Figure 3

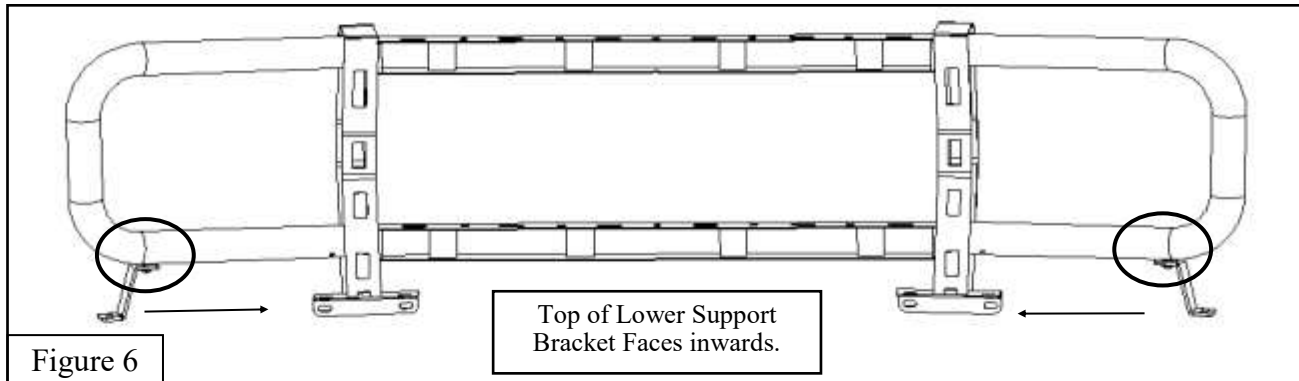
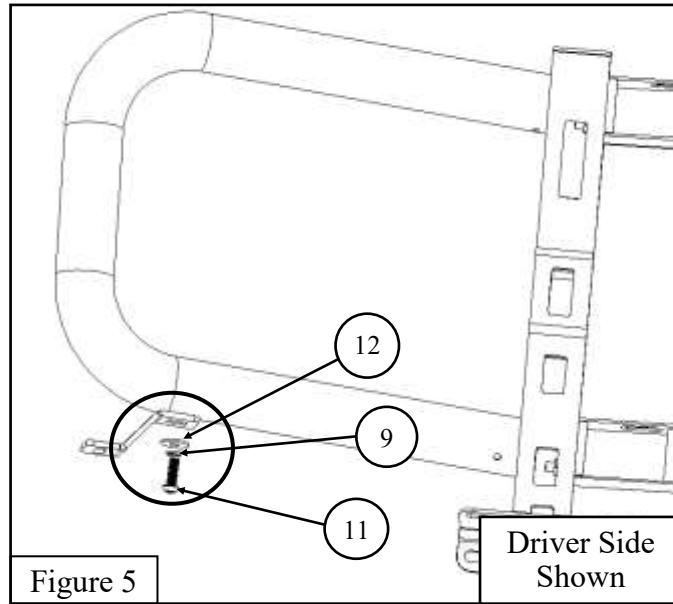

Figure 4

WESTIN

Westin Automotive Products, Inc.
320 W. Covina Blvd
San Dimas, Ca. 91773

5. Line up the Brush Guard assembly to the bumper holes and fasten it with factory bolts removed in **Step 3**.
6. Locate the Driver Side Lower Support Bracket (**Item 4**) and attach it to Brush Guard assembly using the supplied M8 hardware (**Items 9, 11, 12**). See **Figure 5** for reference.
7. Attach the other end of the support bracket to the OE bumper using bolts removed in **Step 4**. See **Figure 6** for reference.
Note: *The side where the Lower Support Bracket attaches to the brush guard will face inwards, towards the center of the vehicle.*
8. Repeat **Steps 7 and 8** for the Passenger Side Lower Support Bracket (**Item 5**).
9. Tighten and torque the M8 hardware to 15-18 ft-lbs.



10. Remove the OEM frame extensions by removing the factory bolts shown in **Figure 7**. Save these bolts as they will be used to attach the Frame Support Brackets.
11. Remove the bolts shown from the factory bumper and save these bolts as they will be used to attach the Frame Support Brackets. See **Figure 8** for reference.
12. Locate the Passenger Frame Support Bracket (Item 7), and attach it to the frame and factory bumper using the bolts removed in **Steps 10 and 11**. See **Figure 9** for reference.

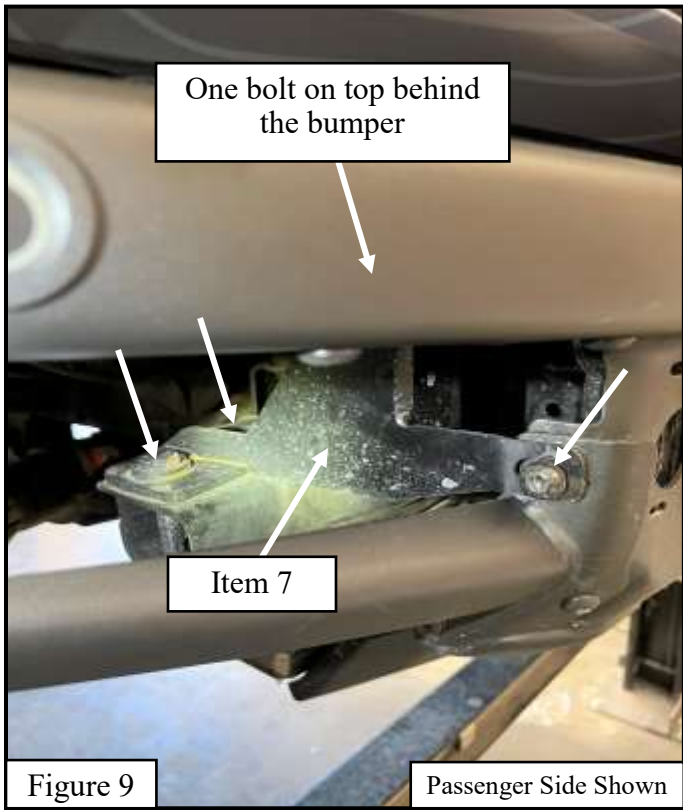
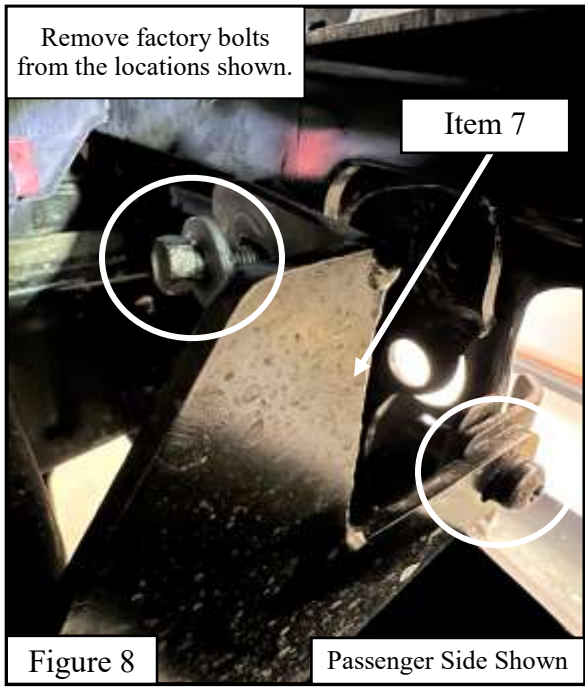
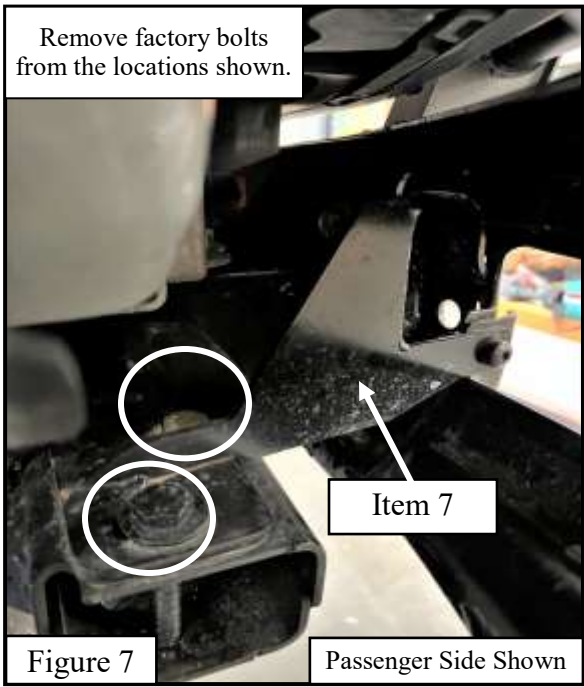

INSTALLATION COMPLETE



CARE INSTRUCTIONS

- REGULAR WAXING IS RECOMMENDED. DO NOT USE ANY TYPE OF POLISH OR WAX THAT MAY CONTAIN ABRASIVES.
- STAINLESS STEEL PRODUCTS CAN BE CLEANED WITH MILD SOAP AND WATER. STAINLESS STEEL POLISH SHOULD BE USED TO POLISH SMALL SCRATCHES.
- GLOSS BLACK FINISHES SHOULD BE CLEANED WITH MILD SOAP AND WATER.

WESTIN Westin Automotive Products, Inc.
320 W. Covina Blvd
San Dimas, Ca. 91773

Thank you for choosing Westin products
for additional installation assistance please call
Customer Service (800) 793-7846
www.westinautomotive.com



WARNING



Failure to follow these instructions could lead to death, personal injury, and / or property damage.

Failure to follow these instructions could lead to death, personal injury, and / or property damage.

FASTENERS:

All Westin supplied fasteners must be utilized and installed in accordance with the installation instructions and apply torque to the specifications as defined. **DOUBLE CHECK ALL FASTENERS BEFORE INITIAL USE, AND PERIODICALLY IN THE FUTURE TO ENSURE PROPER FUNCTION AND SAFETY.**

DRILLING:

Most Westin products do not require drilling for installation. If drilling is defined as required, use caution when drilling a vehicle. **FAILURE TO REVIEW AN AREA TO BE DRILLED MAY RESULT IN PERSONAL INJURY AND/OR INJURY TO OTHERS AS WELL AS VEHICLE DAMAGE.**

EYE PROTECTION:

ALWAYS WEAR SAFETY GLASSES OR GOGGLES DURING THE INSTALLATION PROCESS TO AVOID PERSONAL INJURY.

MAXIMUM TOWING/CARRYING CAPACITY: (if applicable)

The Westin Receiver Hitches will have a visible tow rating label affixed directly on the product. User should never exceed the vehicle manufacturers maximum tow and weight rating regardless of the capacity of the hitch. **FAILURE TO FOLLOW THESE GUIDELINES WILL VOID THE WESTIN WARRANTY AND MAY RESULT IN PERSONAL INJURY AND/OR INJURY TO OTHERS AS WELL AS VEHICLE DAMAGE.**

FOR CALIFORNIA RESIDENTS ONLY-PROP 65 WARNING:

Some products may contain chemicals such as DEHP, which can cause cancer, birth defects or other reproductive harm. For more info go to www.p65warnings.ca.gov



Westin Automotive Products, Inc.
320 W. Covina Blvd
San Dimas, Ca. 91773