

Installation Instructions

I - Sheet Number BF83 Rev.A



Bugflector[®] - Bugflector II[®] - Carflector[®] - Chrome Hood Shield[™]

For proper installation and best possible fit, please read all instructions **BEFORE** you begin.
For technical assistance or to obtain missing parts, please call Customer Relations at 1-800-241-7219.

Important Safety Information



- CAUTION - Before driving, ensure that the hood shield is properly secured to vehicle.
- Do not use automatic "brush-style" car washes.
- Do not use cleaning solvents of any kind.
- Periodically check all components for tightness.

Contents

NOTE: Actual product may vary from illustration.



Hood shield



Bump On
x4



Hood Insert
x4



Washer
x4

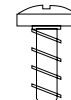

Screws
x4

Tools Required



Car Wash Supplies

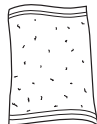

Clean Towel

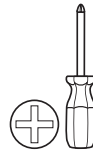

Phillips
screwdriver

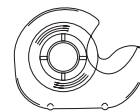

Tape

Preparation Before Painting / Installation

- A trial fit is recommended to ensure proper positioning and fit.
- Check fit of parts before painting as we will not accept the return of modified or painted parts.
- Wash and dry your vehicle to remove any debris and/or dirt from the installation area.

Installation Steps

NOTE: Actual application may vary slightly from illustrations.

Open hood. Locate rubber weatherstrip on leading edge of hood.

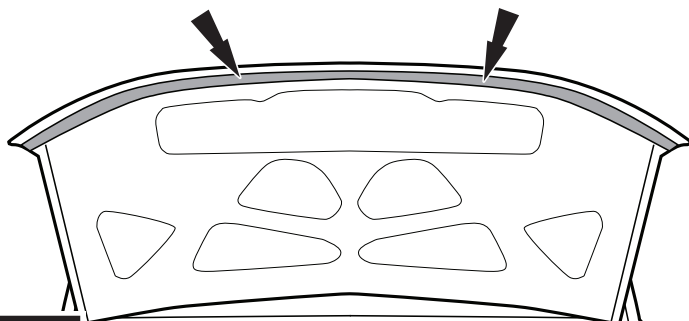

1

Gently pull the edge of the weatherstrip down to reveal (4) square holes.

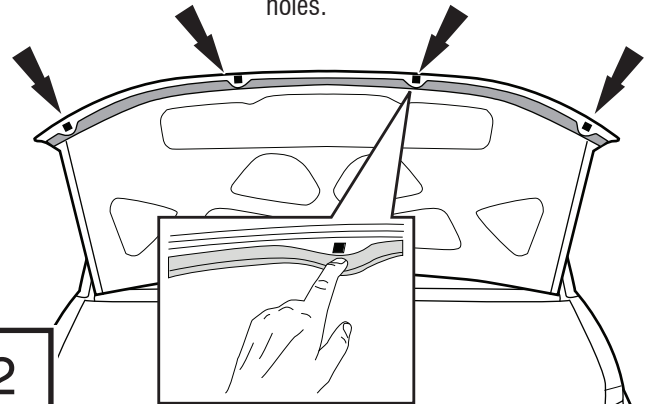

2

Installation Steps

NOTE: Actual application may vary slightly from illustrations.



Press (4) hood inserts into the (4) square holes. If necessary use tape to hold them firmly in place.

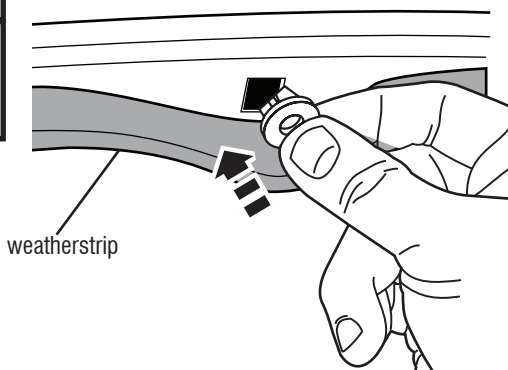

weatherstrip

3

Set the hood shield in place, aligning hood shield holes with the previously installed hood inserts.

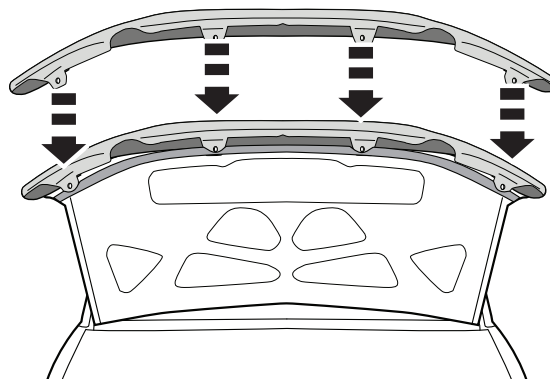

4



Using a phillips screwdriver install (4) screws with (4) washers through the hood shield and into the hood inserts.

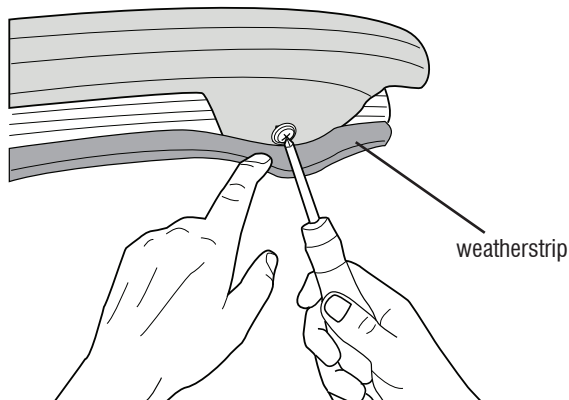
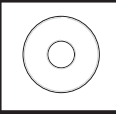

weatherstrip

5

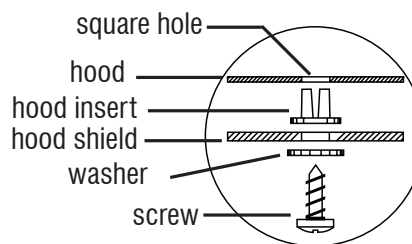

DO NOT OVER TIGHTEN

Reposition the rubber weatherstrip back in place **OVER** the hood shield flanges.

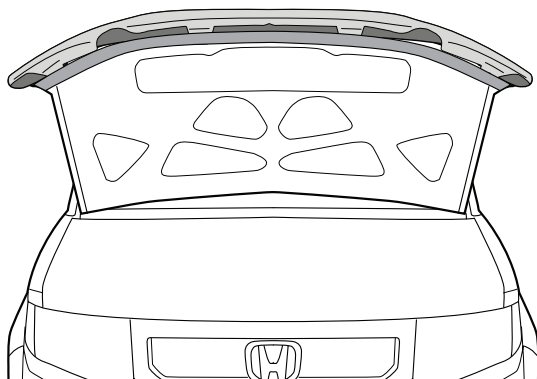

6



Close hood. Install bump ons at pre-cleaned locations on the painted hood/fender surface.

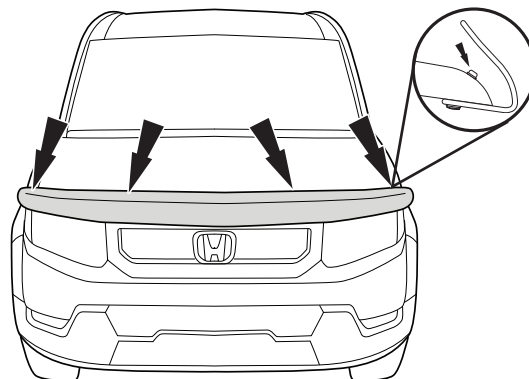

7

Care and Cleaning

- Wash only with mild soap & dry with a clean cloth.

Congratulations!

You have purchased one of the many quality Auto Ventshade™ branded products offered by Lund International, Inc. We take the utmost pride in our products and want you to enjoy years of satisfaction from your investment. We have made every effort to ensure that your product is top quality in terms of fit, durability, finish and ease of installation.



AUTO VENTSHADE™

Lund International, Ventshade Accessories Division

655 Raco Drive, Lawrenceville, GA 30045

800-241-7219 • Fax 770-339-5839 • Visit us at lundinternational.com

© 2009 Lund International, Inc. All rights reserved.



Auto Ventshade™, the Auto Ventshade™ logo, Chromelector™, and the AVS™ logo are trademarks of Lund International, Inc.



Instructions d'installation

I- Feuille numéro BF83 Rév.A



Bugflector® - Bugflector II® - Carflector® - Chrome Hood Shield™

Pour obtenir une installation correcte et le meilleur ajustement possible, lire toutes les instructions AVANT de commencer. Pour toute assistance technique ou obtention de pièces manquantes, appeler le service des relations avec la clientèle au 1-800-241-7219.

Informations importantes concernant la sécurité



- ATTENTION – Avant de conduire, s'assurer que le pare-insectes est solidement assujettie sur le véhicule.
- Ne pas utiliser les stations de lavage de voitures à brosse.
- Ne pas utiliser de solvants.
- Vérifier régulièrement le serrage des composants.

Contenu

NOTE: Le produit réel peut changer de l'illustration.



Protecteur pour capot



Tampon
x4



Attache capot
x4



Rondelle
x4

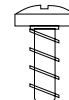

Vis
x4

Outils nécessaires



Matériel de lavage
de la voiture

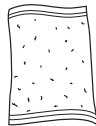

Chiffon propre



Tournevis
Phillips

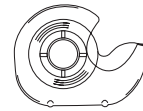

Ruban adhésif

Préparation pour la peinture/l'installation

- Il est recommandé de procéder à un essai pour s'assurer que le positionnement et l'ajustement sont corrects.
- Vérifier l'ajustement des pièces avant peinture, car nous n'acceptons pas le retour de pièces modifiées ou peintes.
- Laver les glissières de glaces de la portière du véhicule pour éliminer toute poussière et tous débris.
- Sécher les glissières avec une serviette propre.

Étapes d'installation

REMARQUE : La méthode d'application peut être légèrement différente de celle représentée par les illustrations.

Ouvrez le capot. Repérez la bande d'étanchéité en caoutchouc située sur le bord du capot.

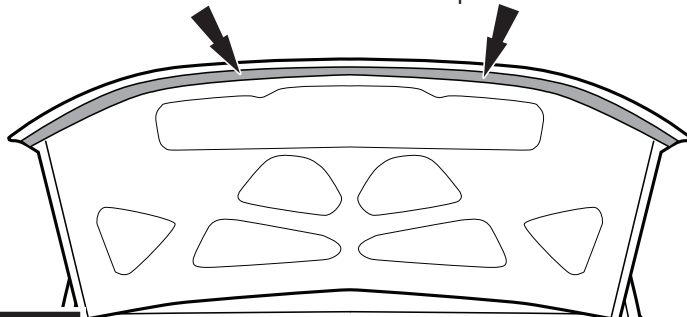

1

Retirez légèrement le bord de la bande d'étanchéité pour voir les (4) trous carrés.

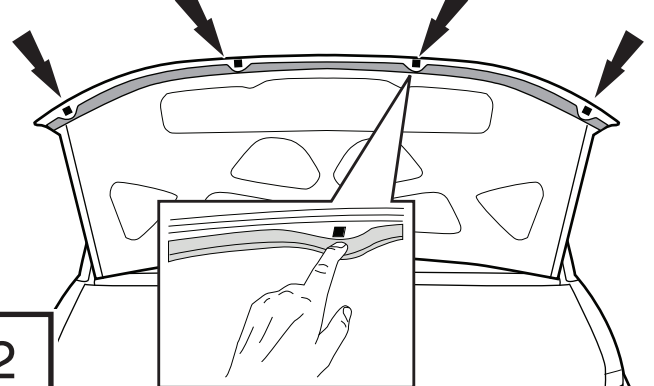

2

Étapes d'installation

REMARQUE : La méthode d'application peut être légèrement différente de celle représentée par les illustrations.

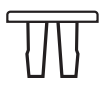

Insérez les (4) attaches capot dans les (4) trous carrés. Si nécessaire, utilisez du ruban adhésif pour les placer correctement et garantir une bonne adhérence.

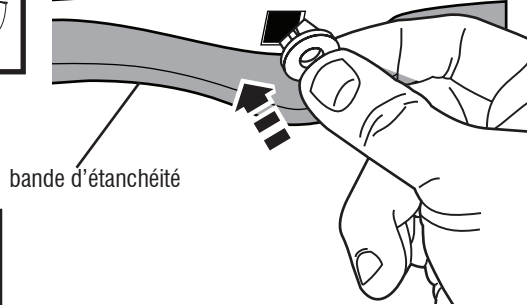

3

Placez le protecteur pour capot en vous assurant que les trous du protecteur sont bien alignés avec les attaches installées antérieurement sur le capot.

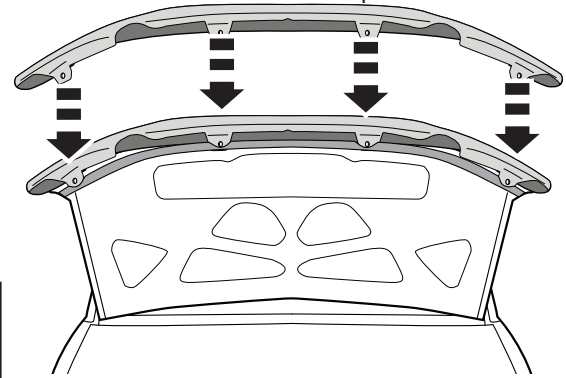

4

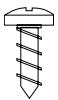

À l'aide d'un tournevis phillips, installez les (4) vis avec les (4) rondelles sur le protecteur et vissez-les dans les attaches du capot.

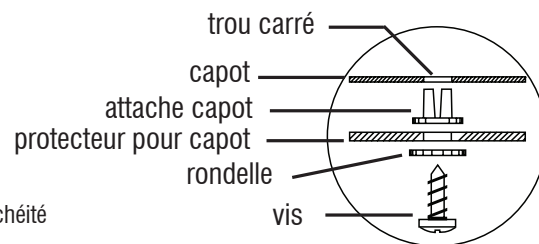
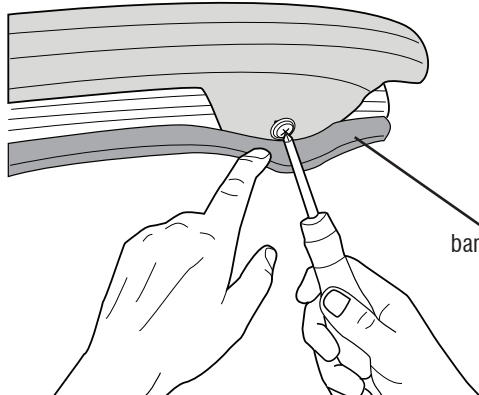

5

NE PAS SERRER TROP FORT

Remettez la bande d'étanchéité en caoutchouc en place **SUR** les brides du protecteur du capot.

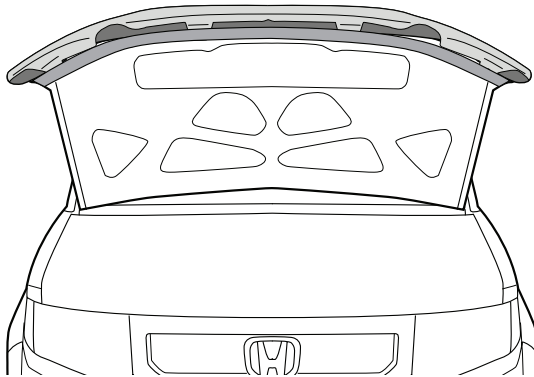

6



Fermez le capot. Placez les tampons sur les points nettoyés sur le dessus du capot (partie centrale et parties latérales).

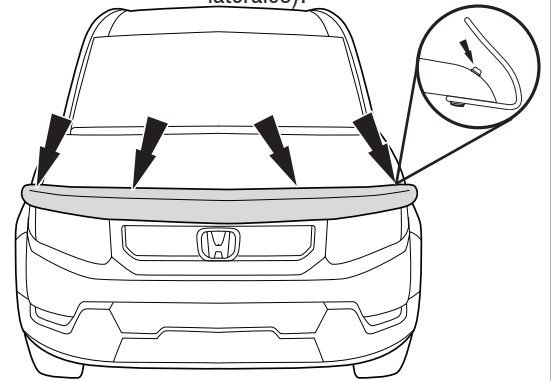

7

Entretien et nettoyage

- Laver exclusivement avec de l'eau savonneuse et sécher avec un chiffon propre.

Félicitations !

Vous avez acheté l'un des nombreux produits de qualité Auto Ventshade™ fabriqués par Lund International, Inc. Nous sommes extrêmement fiers de nos produits et souhaitons que vous tiriez des années de satisfaction de votre investissement. Nous avons pris toutes les mesures nécessaires pour assurer que ce produit est d'une qualité supérieure en ce qui concerne l'ajustement, la durabilité, la finition et la facilité d'installation.



AUTO VENTSHADE™

Lund International, Ventshade Accessories Division

655 Raco Drive, Lawrenceville, GA 30045, USA

800-241-7219 • Fax 770-339-5839 • Visitez notre site lundinternational.com

© 2009 Lund International, Inc. Tous droits réservés.



Auto Ventshade™ le logo Auto Ventshade™, Chromeflector™ et le logo AVS™ sont des marques déposées de Lund International, Inc.



Instrucciones de instalación

Hoja informativa N.º BF83 Rev. A



Bugflector® - Bugflector II® - Carflector® - Chrome Hood Shield™

Para una instalación adecuada y el mejor ajuste posible, lea todas las instrucciones ANTES de comenzar. Si desea recibir asistencia técnica u obtener piezas faltantes, llame al Servicio al cliente al 1-800-241-7219.

Información importante de seguridad



- PRECAUCIÓN - Antes de conducir, asegúrese de que la visera deflectora esté correctamente anclada al vehículo.
- No utilice servicios automáticos de limpieza de vehículos que utilizan cepillos.
- No utilice limpiadores al solvente de ningún tipo.
- Compruebe periódicamente que todos los componentes estén ajustados.

Contenido

NOTA: El producto real puede variar de la ilustración.



Protector para capó



Salientes
x4



Inserto de capó
x4



Arandela
x4



Tornillos
x4

Herramientas necesarias



Suministros para lavado de coches



Toalla limpia



Destornillador
Phillips

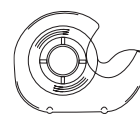

Cinta adhesiva

Preparación antes de pintar o instalar

- Se recomienda realizar un ajuste de prueba para asegurar el posicionamiento y ajuste correctos.
- Compruebe que las piezas se ajusten correctamente antes de pintarlas, ya que no aceptaremos la devolución de piezas modificadas o pintadas.
- Lave los canales de la ventanilla del vehículo para quitar los desechos y la suciedad.
- Seque los canales de la ventanilla con una toalla limpia.

Pasos de instalación

NOTA: El uso real puede variar levemente de ilustraciones.

Abra el capó. Localice el burlete de goma en el borde del capó.

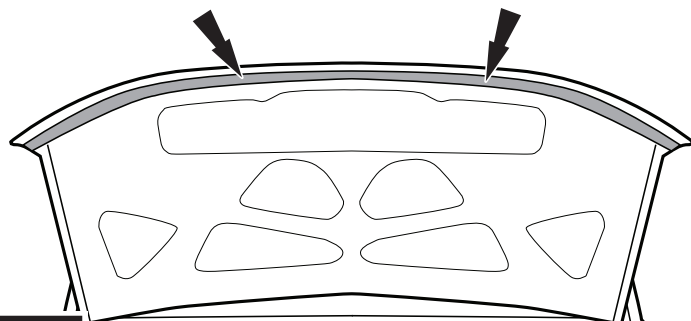

1

Aparte con cuidado el borde del burlete para mostrar los agujeros cuadrados (4).

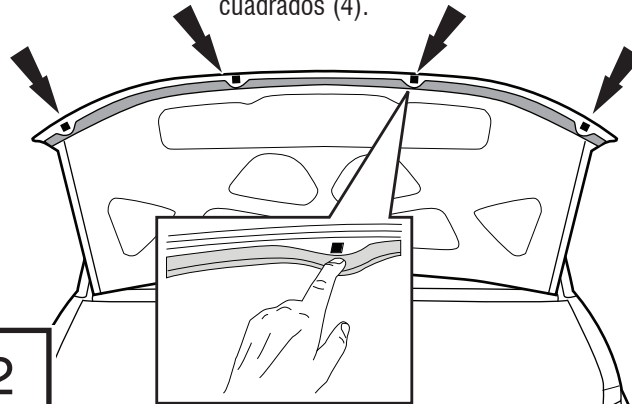

2

Pasos de instalación

NOTA: El uso real puede variar levemente de ilustraciones.

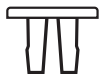

Coloque los (4) insertos del capó en los (4) agujeros cuadrados. Si es necesario utilice cinta adhesiva para una fijación sólida y una máxima adherencia.

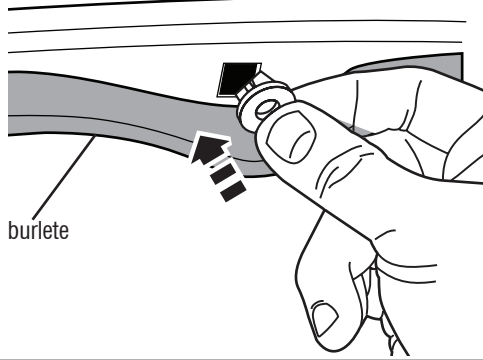

3

Coloque el protector del capó en posición y asegúrese de que los agujeros del protector estén alineados con los insertos del capó previamente colocados.

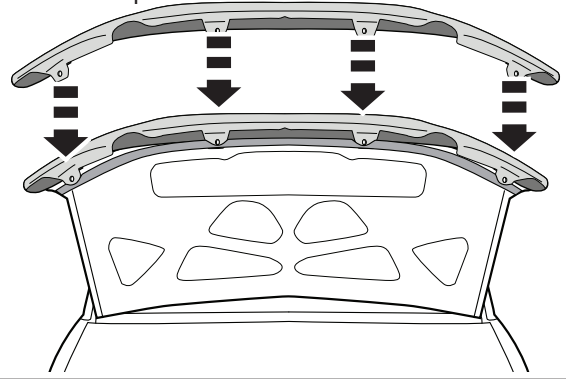

4

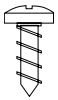

Con un destornillador phillips instale los (4) tornillos con las (4) arandelas y atornille el protector a los insertos del capó.

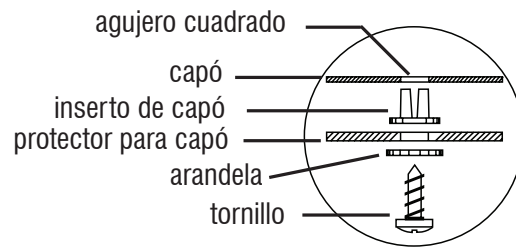
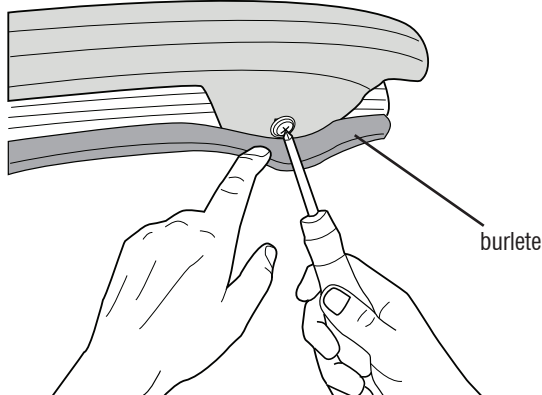

5

NO APRETAR DEMASIADO

Coloque correctamente el burlete de goma en posición **SOBRE** las bridas del protector de capó.

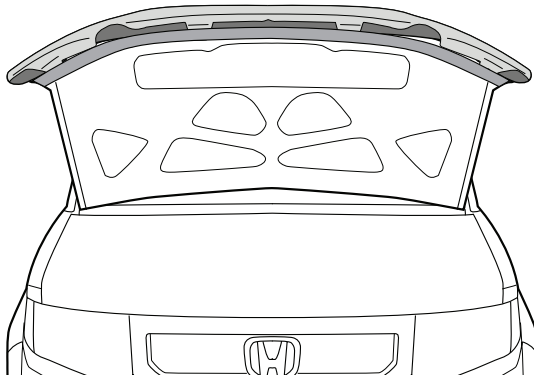

6



Cierre el capó. Aplique los salientes sobre los puntos anteriormente limpiados a la superficie del capó y los guardabarros.

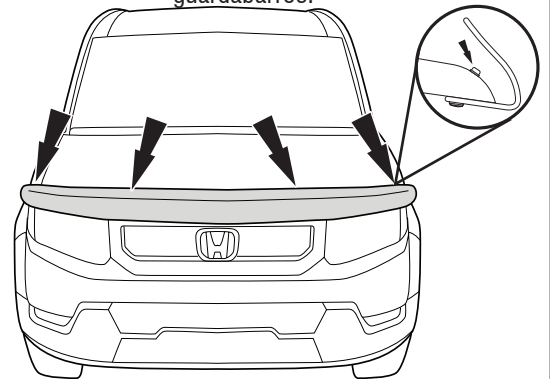

7

Cuidado y limpieza

- Limpie solamente con agua jabonosa tibia y seque con un paño limpio.

Felicidades

Usted ha comprado uno de los tantos artículos de calidad de Auto Ventshade™ ofrecidos por Lund International, Inc. Nuestros productos son nuestro mayor orgullo. Deseamos que disfrute de años de satisfacción con su inversión. Hemos realizado todos los esfuerzos para asegurarnos de que su producto sea de la mejor calidad en cuanto a ajuste, durabilidad, acabado y facilidad de instalación.



AUTO VENTSHADE™

Lund International, Ventshade Accessories Division

655 Raco Drive, Lawrenceville, GA 30045

800-241-7219 • Fax 770-339-5839 • Visite nuestro sitio Web: lundinternational.com

© 2009 Lund International, Inc. Todos los derechos reservados.



™ Auto Ventshade™ el logo de Auto Ventshade™, Chromeflector™ y el logo de AVS™ son marcas comerciales de Lund International, Inc.

