

For 6.5' bed lengths components must be configured for Passenger or Drivers-Side as shown.

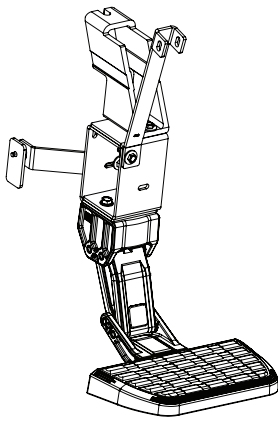

Driver-Side Orientation

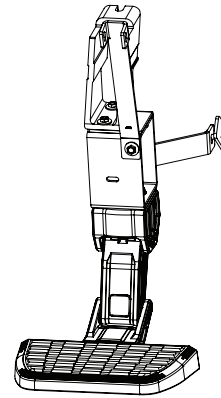

Passenger-Side Orientation

For 5.5' bed length components must be configured for Passenger or Drivers-Side as shown.

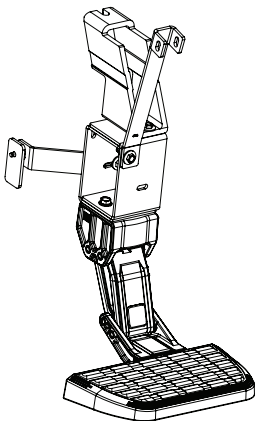

1 Driver-Side Orientation

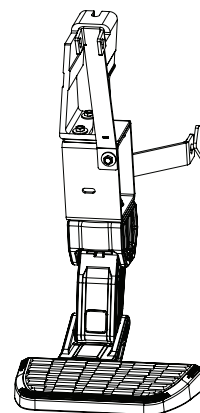

Passenger-Side Orientation

AMP RESEARCH TECH SUPPORT 1-888-983-2204 (Press 2) Monday - Friday, 6:00 AM - 5:00 PM PST

BedStep²™ is invented, designed, engineered and manufactured exclusively by AMP Research and may be covered by one of the following patents: 6,641,158; 6,830,257; 6,938,909; 7,055,839; 7,380,807; 7,398,985; 7,584,975. Made in USA © 2011 AMP Research
Three-year limited warranty. Professional installation is recommended.

Using a 13mm Socket and wrench assemble the frame mount to the lateral mounting brackets. Use bolts (#10) and nuts (#13). Note orientation of brackets. Torque bolts to 16 ft-lbs.

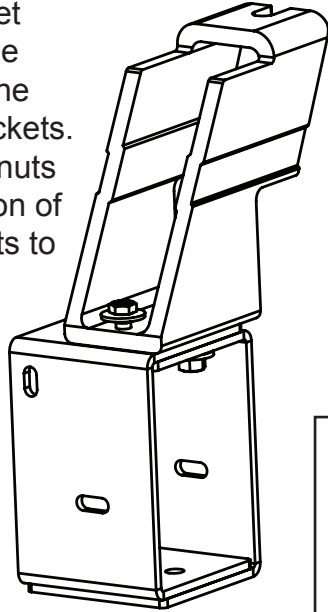

2



Assemble Linkage to bracket assembly using a 15mm Socket or wrench. Use supplied flange Bolts (#9). Do not tighten bolts, leave loose to adjust linkage in a later step.

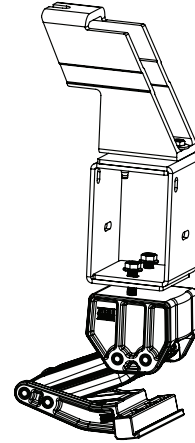

3

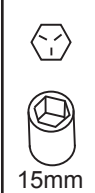

Loosen factory bed bolt using a 15mm socket with extension. Loosen enough to slide bracket assembly into position.

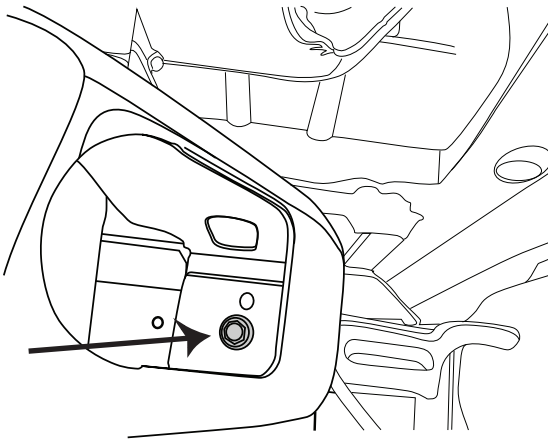

4



Set linkage assembly into position and tighten bed bolt. Torque bed bolt to 40ft-lbs.

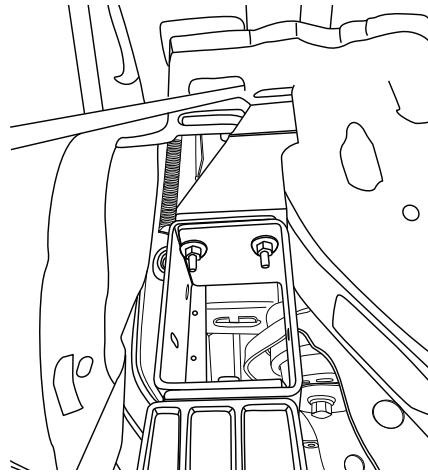

5

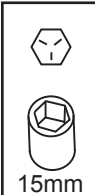

Assemble Rear support Bracket (#5). Use Bolt (#12) and nut (#13) on linkage assembly and Bolt (#12) and threaded nut plate (#8) on Frame. Torque bolts to 16ft-lbs.

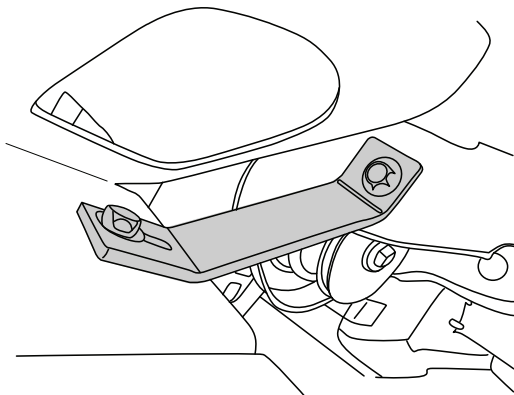

6



Locate factory bed bolt. Using a 13mm socket or wrench remove bolt.

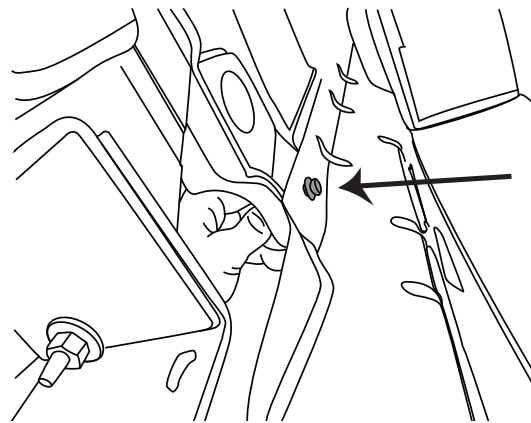

7

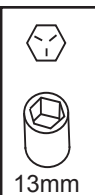

Using factory bolt removed in previous step attach bracket to bed. Use supplied Bolt (#12) and Nut (#13) to attach bracket to linkage assembly. Torque bolts to 16ft-lbs.

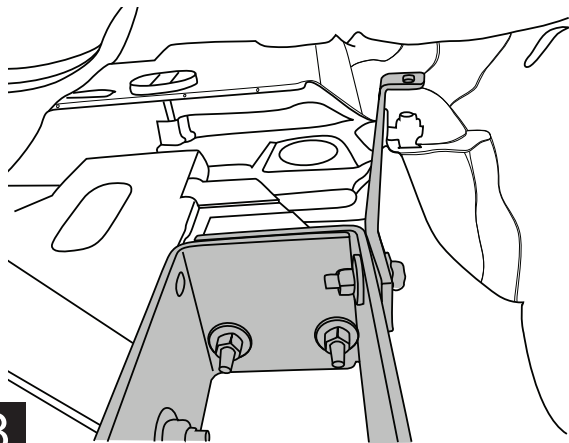

8



13mm

Install step pad (#2) onto linkage. Torque to 5ft-lbs.
6.5' bed applications center step pad on linkage (As shown).
5.5' bed applications offset step pad forward on linkage.

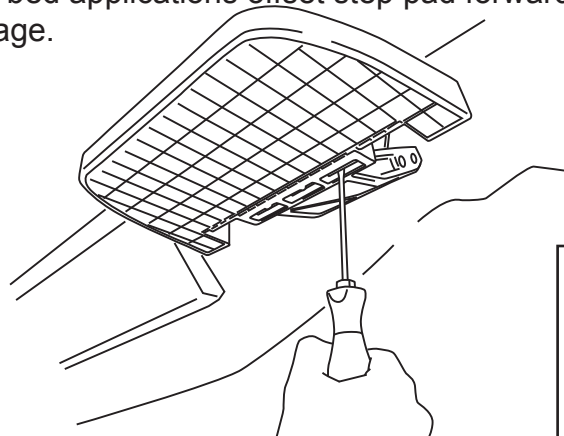

9

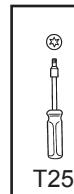

T25

Verify step pad alignment to body line of vehicle.

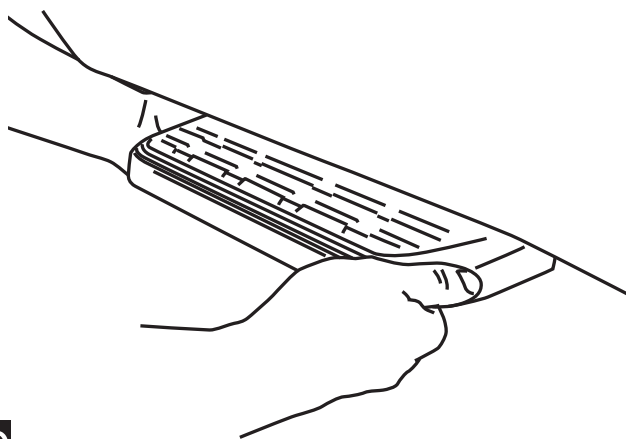

10

Tighten linkage bolts using a socket or wrench. Torque bolts to 20ft-lbs.

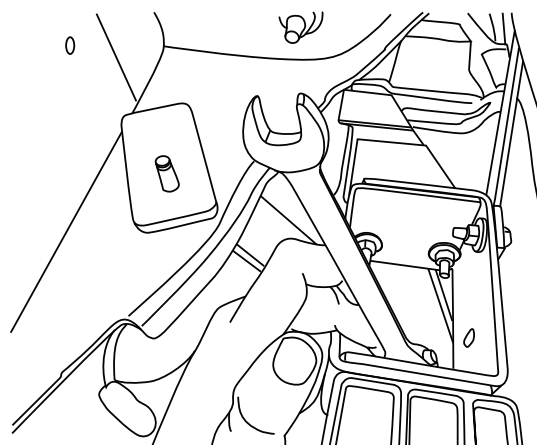

11

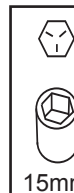

15mm

To deploy the step, press down using your foot on the outside edge of the step pad.

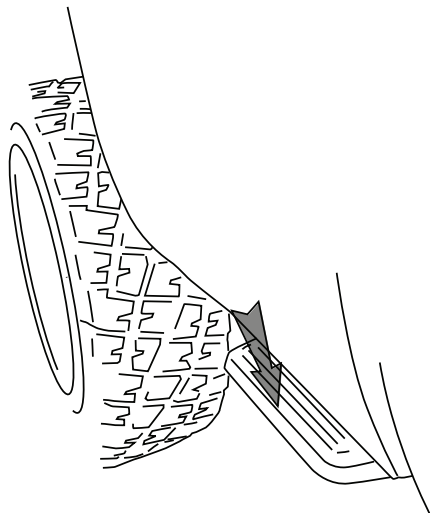

12

To retract, gently kick up on the underside of the step pad.

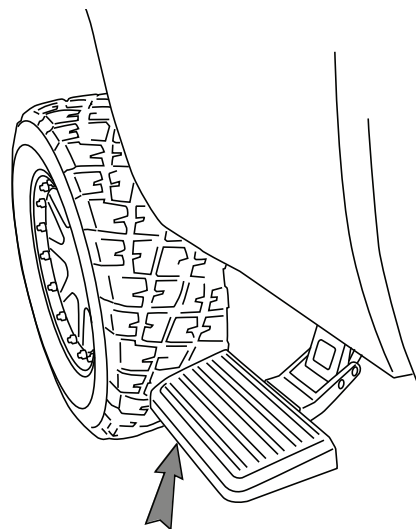

13



Congratulations on your purchase of the genuine AMP Research BedStep2™. Here's what you should know...

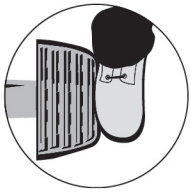

BEDSTEP2™ OPERATION

The AMP Research BedStep2™ is foot operated and deploys and retracts with a nudge of your foot. To deploy, press down using your foot, on the outside edge of the step pad.

Maximum load capacity of the deployed step pad is 300 lbs.

Always use appropriate hand holds when stepping up to or down from your truck's cargo bed.



To retract, gently kick up on the underside of the step pad.

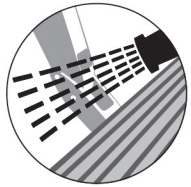

MAINTENANCE TIPS - The stepping surface and linkage should be periodically washed with mild soap and water using a soft brush or sponge to dislodge any mud, dirt or accumulated road grime.

In severe driving conditions, pressure washing the linkage is strongly recommended.

Do not apply silicone spray, waxes or protectants like Armor All® to the stepping surfaces.

CAUTION! BEDSTEP2™ SHOULD ALWAYS BE STOWED IN THE RETRACTED POSITION WHEN DRIVING.

AMP RESEARCH LIMITED WARRANTY

AMP RESEARCH warrants this product to be free from defects in material and workmanship for THREE (3) YEARS FROM DATE OF PURCHASE, provided there has been normal use and proper maintenance. This warranty applies to the original purchaser only. All remedies under this warranty are limited to the repair replacement of the product itself, or the repair or replacement of any component part thereof, found by the factory to be defective within the time period specified. The decision to repair or replace is wholly within the discretion of the manufacturer.

This warranty specifically excludes labor. If you have a warranty claim, first you must call our factory at the number below for instructions. You must retain proof of purchase and submit a copy with any items returned for warranty work. Upon completion of warranty work, if any, we will return the repaired or replaced item or items to you freight prepaid. Damage to our products caused by accidents, fire, vandalism, negligence, misinstallation, misuse, Acts of God, or by defective parts not manufactured by us, is not covered under this warranty.

ANY IMPLIED WARRANTIES OF MERCHANTABILITY AND/OR FITNESS FOR A PARTICULAR PURPOSE CREATED HEREBY ARE LIMITED IN DURATION TO THE SAME DURATION AND SCOPE AS THE EXPRESS WRITTEN WARRANTY. OUR COMPANY SHALL NOT BE LIABLE FOR ANY INCIDENTAL OR CONSEQUENTIAL DAMAGE.

Some states do not allow limitations on how long an implied warranty lasts, or the exclusion or limitation of incidental or consequential damages, so the above limitations or exclusions may not apply to you. This warranty gives you specific legal rights, and you may also have other rights that vary from state to state.

FOR WARRANTY ISSUES WITH THIS PRODUCT PLEASE CALL AMP RESEARCH CUSTOMER SERVICE 1-888-983-2204

WARNING

Be sure to read and precisely follow the provided instructions when installing this product. Failure to do so could place the vehicle occupants in a potentially dangerous situation. After installing or reinstalling, re-check to insure that the product is properly installed.