

Installation Instructions

I - Sheet Number W120 Rev.A



Ventvisor® Deflector

**For proper installation and best possible fit, please read all instructions BEFORE you begin.
For technical assistance or to obtain missing parts, please call Customer Relations at 1-800-241-7219.**

Important Safety Information



- CAUTION - Before driving, ensure that the wind deflector is properly secured to vehicle.
- Do not use automatic "brush-style" car washes.
- Do not use cleaning solvents of any kind.
- Periodically check all components for tightness.

Contents - 2 Piece Set

NOTE: Actual product may vary from illustration.



Front Driver
Side Visor

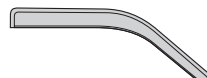

Front Passenger
Side Visor



Alcohol
Pad x2

Contents - 4 Piece Set

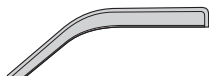

Front Driver
Side Visor

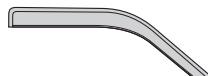

Front Passenger
Side Visor



Rear Driver
Side Visor



Rear Passenger
Side Visor



Alcohol
Pad x4

Tools Required



Putty Knife

Preparation Before Painting / Installation

- A trial fit is recommended to ensure proper positioning and fit.
- Check fit of parts before painting as we will not accept the return of modified or painted parts.
- Wash your vehicle to remove any debris and/or dirt from installation area.
- Dry the installation area with a clean towel.

Installation Steps

NOTE: Actual application may vary slightly from illustrations.

Alcohol Pad

Lower the window. Clean the window frame or the chrome window frame where the visor will attach.

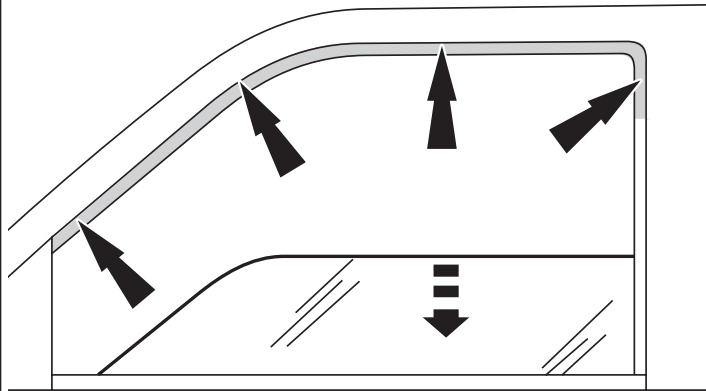

1

Remove the tape liner from the rear flange. Peel back 2" of tape liner from each end of top flange.

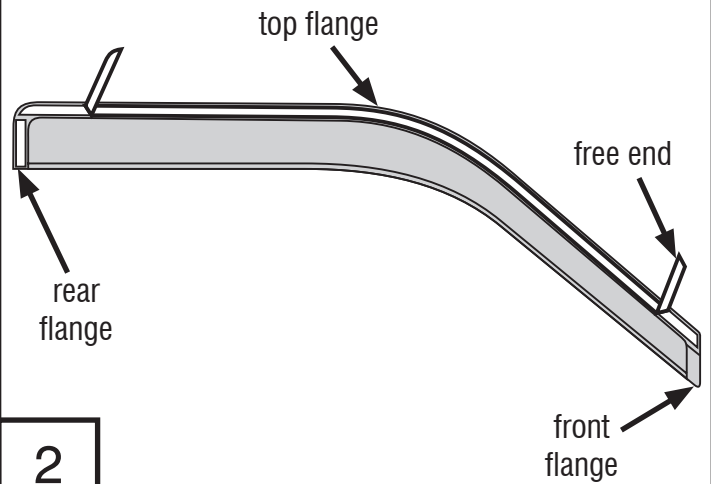

2

Slide the front flange behind the mirror cap, use a putty knife to create a gap if needed. Attach the top and rear flanges to the door's window frame or chrome window frame.

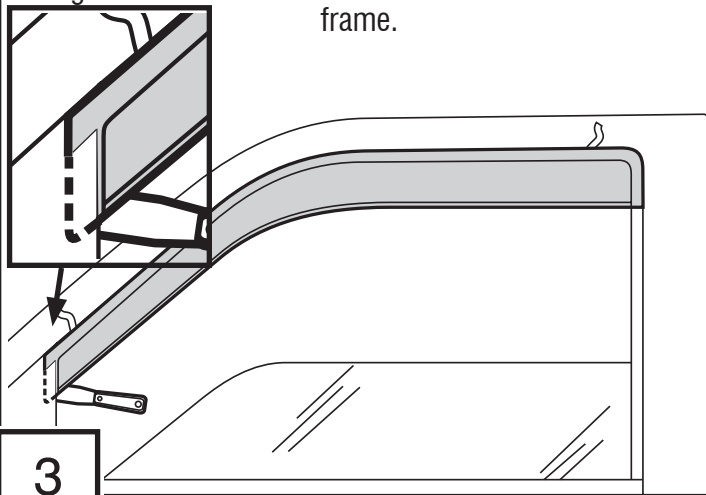

3

Remove tape liner by pulling on free ends. Apply pressure to top and rear tape flanges to secure. Raise the window.

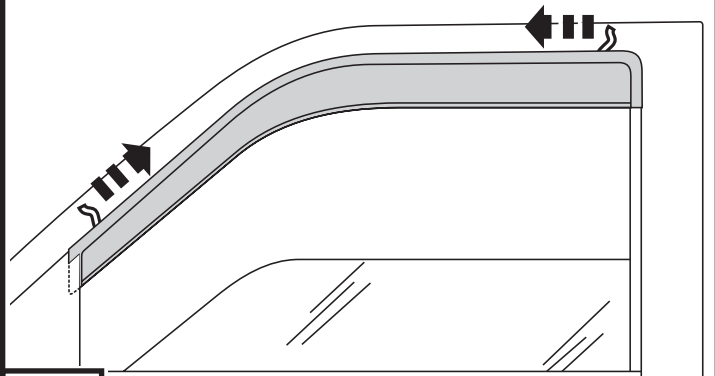

4

4 Piece Set

The rear visor attaches with same preparation methods as the front visor. Attach visor to the window frame or chrome window frame.

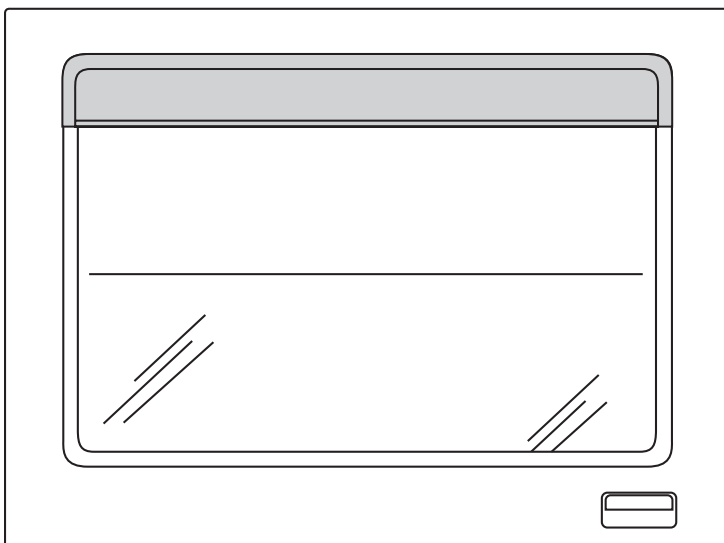

5

OR

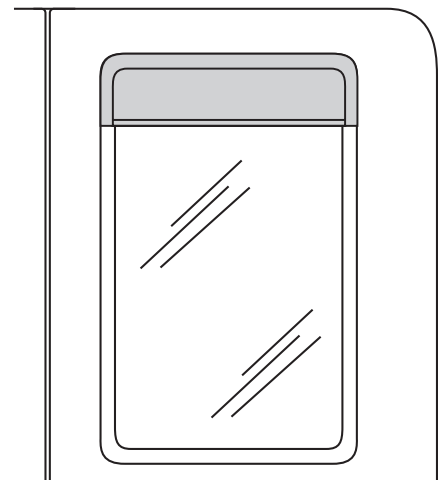

Care and Cleaning

- Wash only with mild soap & dry with a clean cloth.

Congratulations!

You have purchased one of the many quality Auto Ventshade™ branded products offered by Lund International, Inc. We take the utmost pride in our products and want you to enjoy years of satisfaction from your investment. We have made every effort to ensure that your product is top quality in terms of fit, durability, finish and ease of installation.



AUTO VENTSHADE™

Lund International, Ventshade Accessories Division

655 Raco Drive, Lawrenceville, GA 30045

800-241-7219 • Fax 770-339-5839 • Visit us at lundinternational.com



© 2010 Lund International, Inc. All rights reserved.

Auto Ventshade™, the Auto Ventshade™ logo and the AVS™ logo are trademarks of Lund International, Inc.





Défecteur Ventvisor®

Pour obtenir une installation correcte et le meilleur ajustement possible, lire toutes les instructions AVANT de commencer.
Pour toute assistance technique ou obtention de pièces manquantes, appeler le service des relations avec la clientèle au 1-800-241-7219.

Informations importantes concernant la sécurité



- ATTENTION – Avant de conduire, s'assurer que la visière est solidement assujettie sur le véhicule.
- Ne pas utiliser les stations de lavage de voitures à brosses.
- Ne pas utiliser de solvants.
- Vérifier régulièrement le serrage des composants.

Contenu - Ensemble 2 pièces **NOTE:** Le produit réel peut changer de l'illustration.



Visière avant
côté conducteur



Visière avant
côté passager



Tampons à
l'alcool (2)

Contenu - Ensemble 4 pièces



Visière arrière côté
conducteur



Visière avant
côté passager



Visière arrière
côté conducteur



Visière arrière
côté passager



Tampons à
l'alcool (4)

Outils nécessaires



Couteau à mastiquer

Préparation pour la peinture/l'installation

- Il est recommandé de procéder à un essai pour s'assurer que le positionnement et l'ajustement sont corrects.
- Vérifier l'ajustement des pièces avant peinture, car nous n'acceptons pas le retour de pièces modifiées ou peintes.
- Laver les glissières de glaces de la portière du véhicule pour éliminer toute poussière et tous débris.
- Sécher les glissières avec une serviette propre.

Étapes d'installation

NOTE: L'application réelle peut changer légèrement des illustrations.

Alcohol
Pad

Abaisser la glace. Nettoyez le cadre de la fenêtre ou le cadre de la fenêtre chrome où la visière doit être installée.

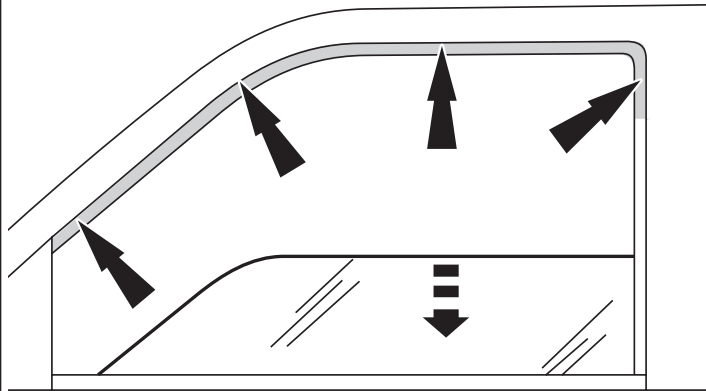

1

Retirer la protection d'adhésif de la patte arrière. Découler environ 5 cm (2 po) de protection d'adhésif à chaque extrémité du rebord supérieur.

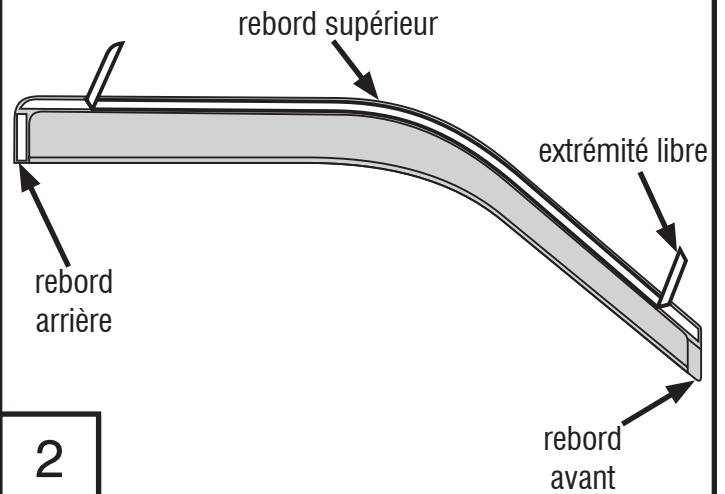

2

Glisser le rebord avant derrière le couvercle de rétroviseur. Fixer les rebords avant et arrière de châssis de fenêtre de la porte ou de fenêtre chrome.

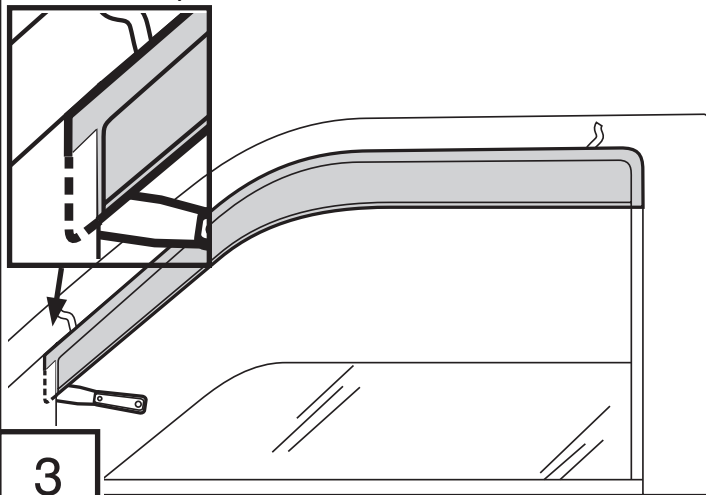

3

Retirer la protection d'adhésif en tirant sur les extrémités libres. Appuyer sur le haut et l'arrière pour faire adhérer le ruban. Relever la vitre.

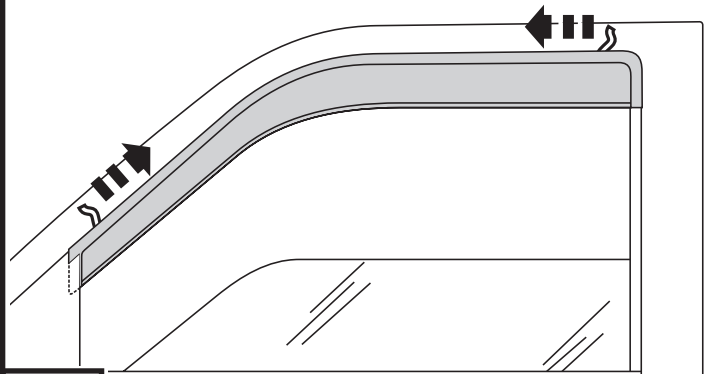

4

Ensemble 4 pièces

L'installation de la visière arrière demande la même préparation que la visière avant. Installer la visière sur le châssis de fenêtre ou de fenêtre chrome.

5

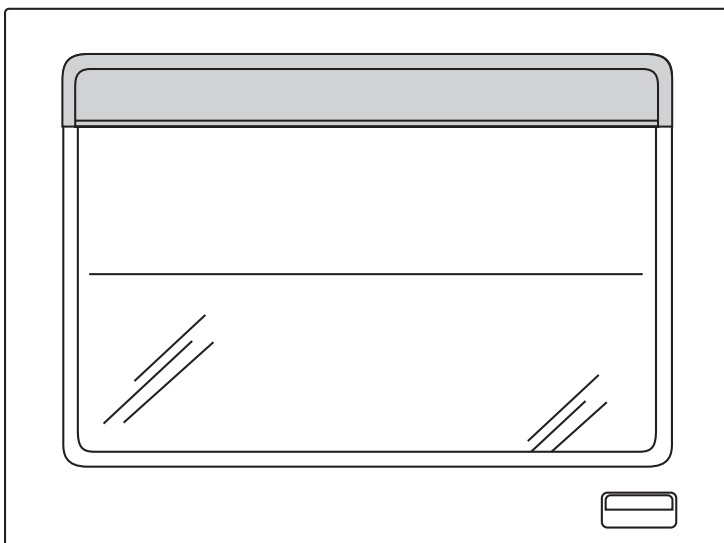

ou

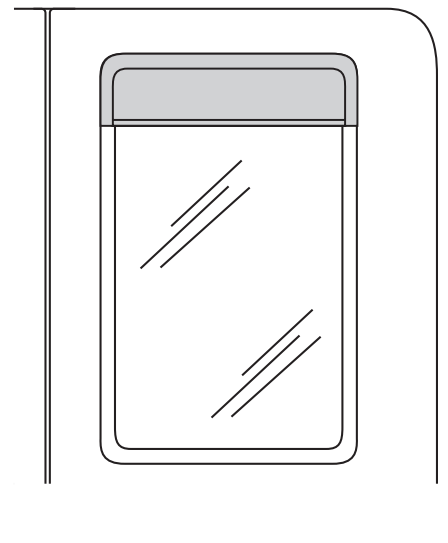

Entretien et nettoyage

- Laver exclusivement avec de l'eau savonneuse et sécher avec un chiffon propre.

Félicitations !

Vous avez acheté l'un des nombreux produits de qualité Auto Ventshade™ fabriqués par Lund International, Inc. Nous sommes extrêmement fiers de nos produits et souhaitons que vous tiriez des années de satisfaction de votre investissement. Nous avons pris toutes les mesures nécessaires pour assurer que ce produit est d'une qualité supérieure en ce qui concerne l'ajustement, la durabilité, la finition et la facilité d'installation.



AUTO VENTSHADE™

Lund International, Ventshade Accessories Division

655 Raco Drive, Lawrenceville, GA 30045, USA

800-241-7219 • Fax 770-339-5839 • Visitez notre site lundinternational.com



© 2010 Lund International, Inc. Tous droits réservés.

Auto Ventshade™, le logo Auto Ventshade™ et le logo AVS™ sont des marques déposées de Lund International, Inc.





Deflector Ventvisor®

Para una instalación adecuada y el mejor ajuste posible, lea todas las instrucciones ANTES de comenzar. Si desea recibir asistencia técnica u obtener piezas faltantes, llame al Servicio al cliente al 1-800-241-7219.

Información importante de seguridad



- PRECAUCIÓN - Antes de conducir, asegúrese de que la visera deflectora esté correctamente anclada al vehículo.
- No utilice servicios automáticos de limpieza de vehículos que utilizan cepillos.
- No utilice limpiadores al solvente de ningún tipo.
- Compruebe periódicamente que todos los componentes estén ajustados.

Contenido - Juego de dos piezas **NOTA:** El producto real puede variar de la ilustración.

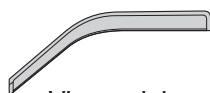

Visera del conductor

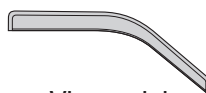

Visera del acompañante



Paño esterilizado x2

Contenido - Juego de cuatro piezas

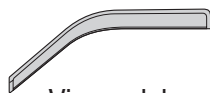

Visera del conductor

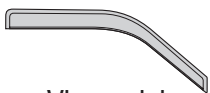

Visera del acompañante



Visera trasera lateral izquierdo



Visera trasera lateral derecho



Paño esterilizado x4

Herramientas necesarias



Espátula

Preparación antes de pintar o instalar

- Se recomienda realizar un ajuste de prueba para asegurar el posicionamiento y ajuste correctos.
- Compruebe que las piezas se ajusten correctamente antes de pintarlas, ya que no aceptaremos la devolución de piezas modificadas o pintadas.
- Lave los canales de la ventanilla del vehículo para quitar los desechos y la suciedad.
- Seque los canales de la ventanilla con una toalla limpia.

Pasos de instalación

NOTA: El uso real puede variar levemente de ilustraciones.

Alcohol
Pad

Baje la ventanilla. Limpie el marco de la ventana o el marco de la ventana del cromo en la visera se fije.

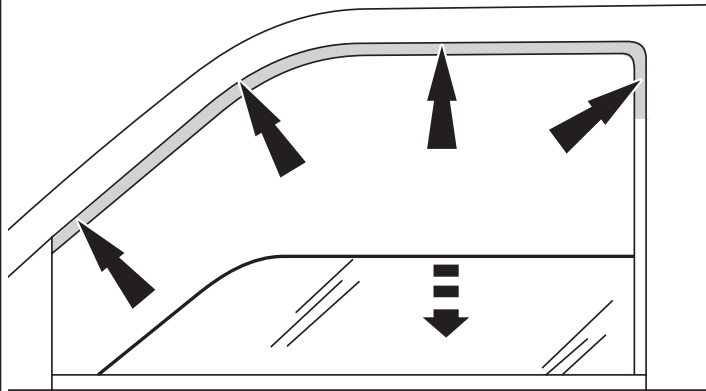

1

Quite la cinta protectora del reborde trasero. Retire 2 pulgs. de cinta protectora de cada uno de los extremos del reborde superior.

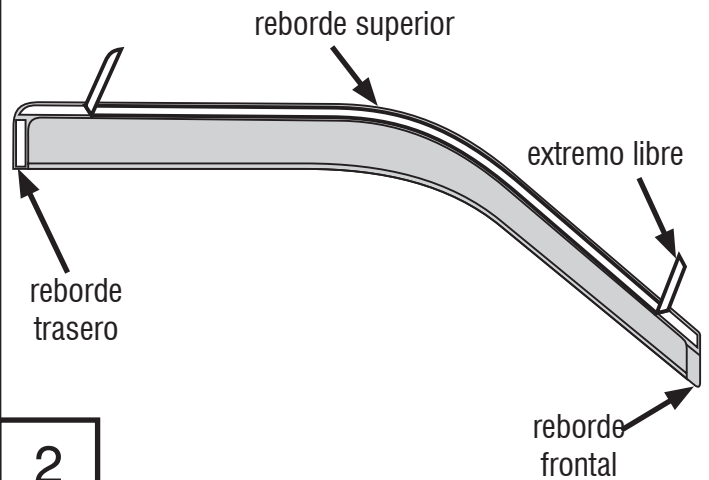

2

Deslice el reborde frontal por detrás de la cubierta del espejo. Coloque las bridas de la parte superior y trasera de marco de la ventana de la puerta o el marco de la ventana de cromo.

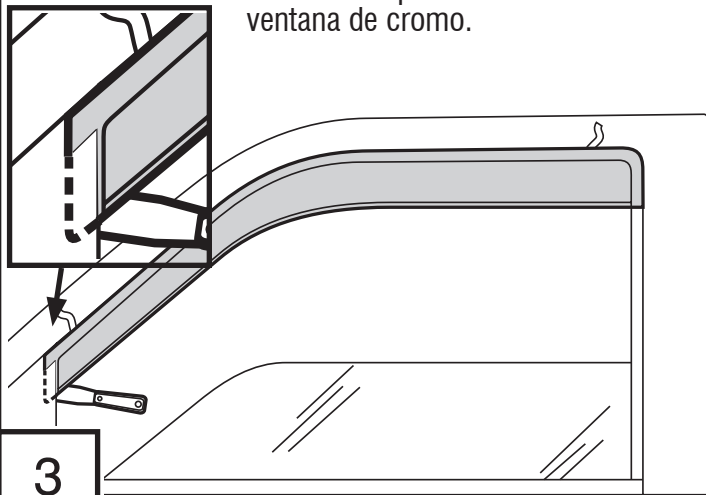

3

Retire la cinta protectora tirando de los extremos libres. Aplique presión sobre los rebordes de cinta superior y trasero para ajustar. Suba la ventanilla.

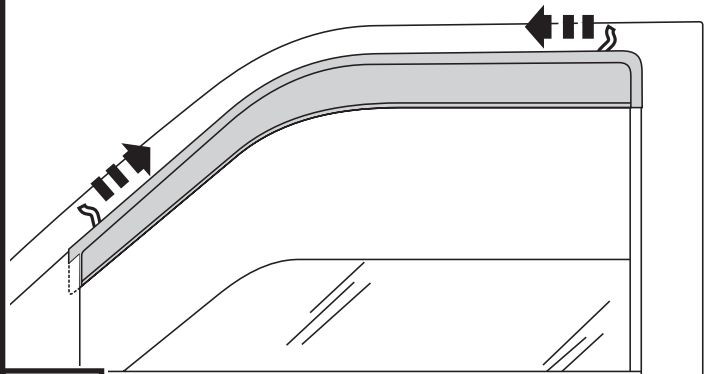

4

Juego de cuatro piezas

La visera trasera se coloca siguiendo los mismos pasos que para la visera frontal. Coloque la visera con el marco de la ventana o el marco de la ventana de cromo.

5

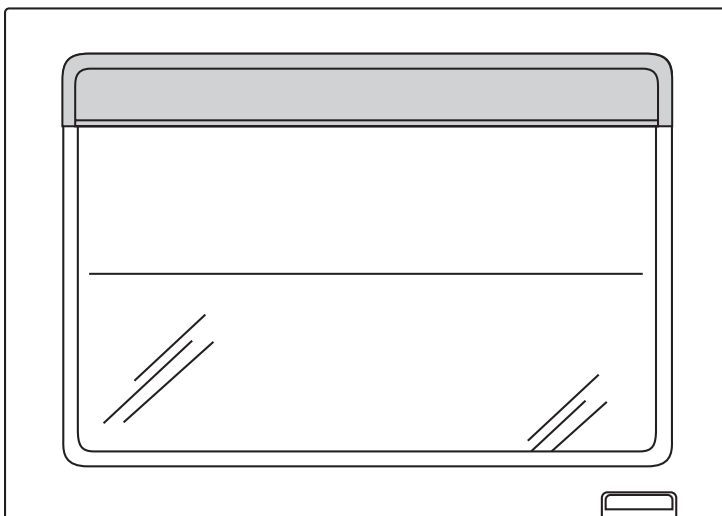

O BIEN

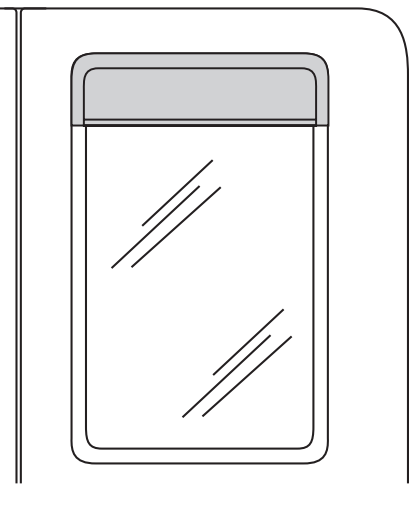

Cuidado y limpieza

- Limpie solamente con agua jabonosa tibia y seque con un paño limpio.

Felicidades

Usted ha comprado uno de los tantos artículos de calidad de Auto Ventshade™ ofrecidos por Lund International, Inc. Nuestros productos son nuestro mayor orgullo. Deseamos que disfrute de años de satisfacción con su inversión. Hemos realizado todos los esfuerzos para asegurarnos de que su producto sea de la mejor calidad en cuanto a ajuste, durabilidad, acabado y facilidad de instalación.



AUTO VENTSHADE™

Lund International, Ventshade Accessories Division

655 Raco Drive, Lawrenceville, GA 30045

800-241-7219 • Fax 770-339-5839 • Visite nuestro sitio Web: lundinternational.com



© 2010 Lund International, Inc. Todos los derechos reservados.

Auto Ventshade™, el logo de Auto Ventshade™ y el logo de AVS™ son marcas comerciales de Lund International, Inc.

