



**2019-2020 Chev Silverado 1500**  
**Nylon 5/8" Offset Mud Flap Set, Front**  
**Mounting Diagram & Instructions**  
**Kit# GCN28F**

**TO BE USED WITH COLOUR MATCH PLUGS – SOLD SEPARATELY**

**IMPORTANT:**

*Manufacturer is not responsible for negligent use of vehicle with mud flaps installed, including over-tightening of screws and bolts causing damage to vehicle or mud flaps.*



**TOOLS REQUIRED-**

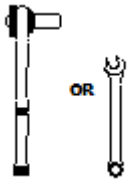

5/16" Open Wrench or  
Socket Wrench

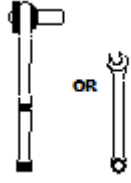

7/16" Open Wrench or  
Socket Wrench

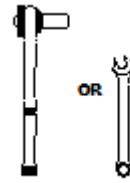

10mm Open Wrench or  
Socket Wrench

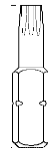

T15 Torx  
Bit

**FLAPS**

(1)Flap Assy  
Rear, DS

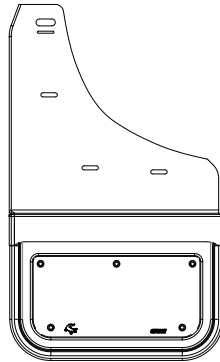

(1)Flap Assy  
Rear, PS

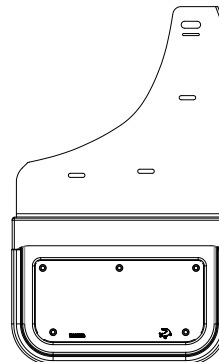

**PARTS BAG # 769253**

a) (2) Washer, Flat  
0.281" x 1", 18g, SS, oxidized  
Part #018069



b) (6) Washer, Flat  
0.203" x 1", 18g, SS, oxidized  
Part #018070



c) (2) Capscrew, SS  
1/4"-20UNC x 3/8", oxidized  
Part #014069



d) (6) Bolt, Hex Flange, SS  
M 4.2 x 1", Black  
Part # 016041

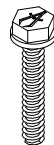

e) (1) Mount Clip, DS  
w/Clinch Nut  
Part # 767068

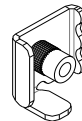

f) (1) Mount Clip, PS  
w/Clinch Nut  
Part #767069

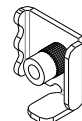

g) (2) Rubber Washer  
1/4"ID x 1"OD x 1/4"  
Part #080677



## INSTALLATION *(For ease of installation it is suggested that the wheel be removed)*

1. Before you install your Mud Flap Set, see the diagram and parts list for all necessary parts. Start on the driver's side.
2. Remove 4 factory screws from holes #1 to #4 as shown in Diagram #1. \*Removal process may vary dependent on the factory guard style.\*
3. Push liner back to expose clip on inside of factory guard. Pinch clip on inside of guard and pull back to remove. If 3M tape has been used to install the factory guard, use alcohol on a microfiber cloth to remove.  
\*\*NOTE: You will see a hole in the side of the body. Colour match plugs are sold separately so that you can select the correct colour for your truck, and seamlessly cover this factory oversight.\*\*
4. Reinstall factory bolt on underside of the fender on hole #1.
5. Remove factory screw from hole #5 and factory u-clip from hole #7 in Diagram #1.
6. Push the factory liner back to install colour match plugs (sold separately) into holes on outside of the fender.
7. Put liner back into place.
8. As shown in diagram #2, install mount clip (e) on hole #4 using supplied bolt (c) and washer (a).
9. Secure the mud flap through hole #1 to hole #5 using supplied bolt (d), washer (b), and rubber spacer (g) and through hole #3 to hole #7.
10. Secure mud flap through hole #2 to hole #6 using supplied bolt (d) and washer (b). Loosely secure at this point.
11. Slide mount clip behind the lip of the fender to secure.
12. Using a bubble level or other levelling tool, ensure that the mud flap is level. Tighten fasteners on holes #1 to #4.
13. Repeat on passenger side.

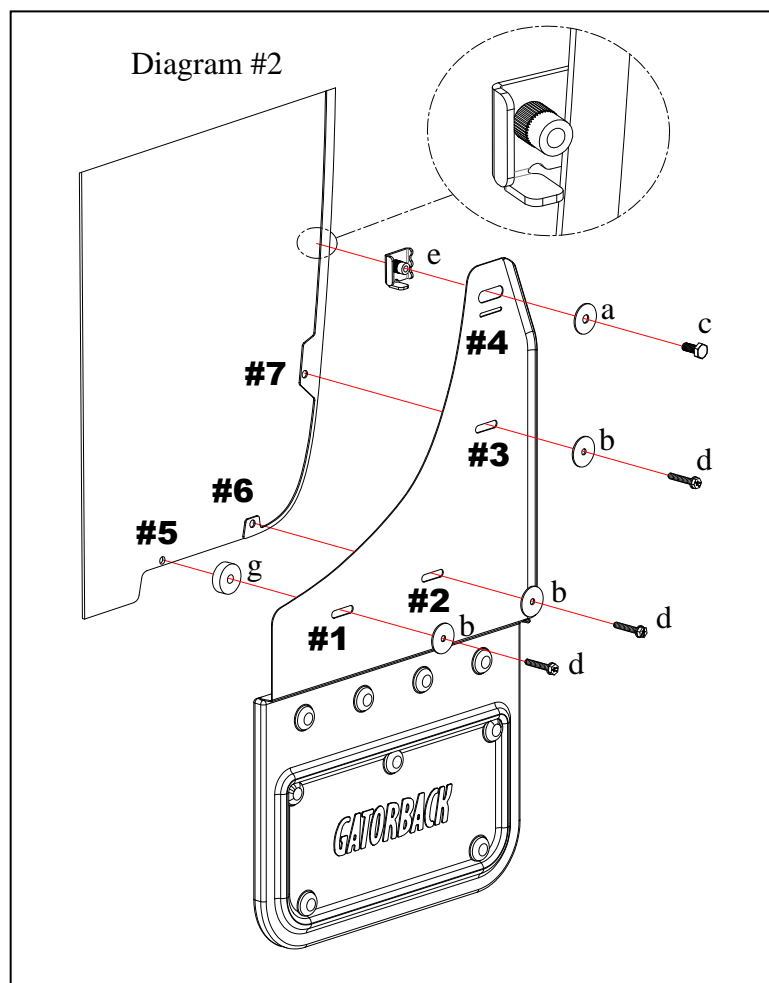
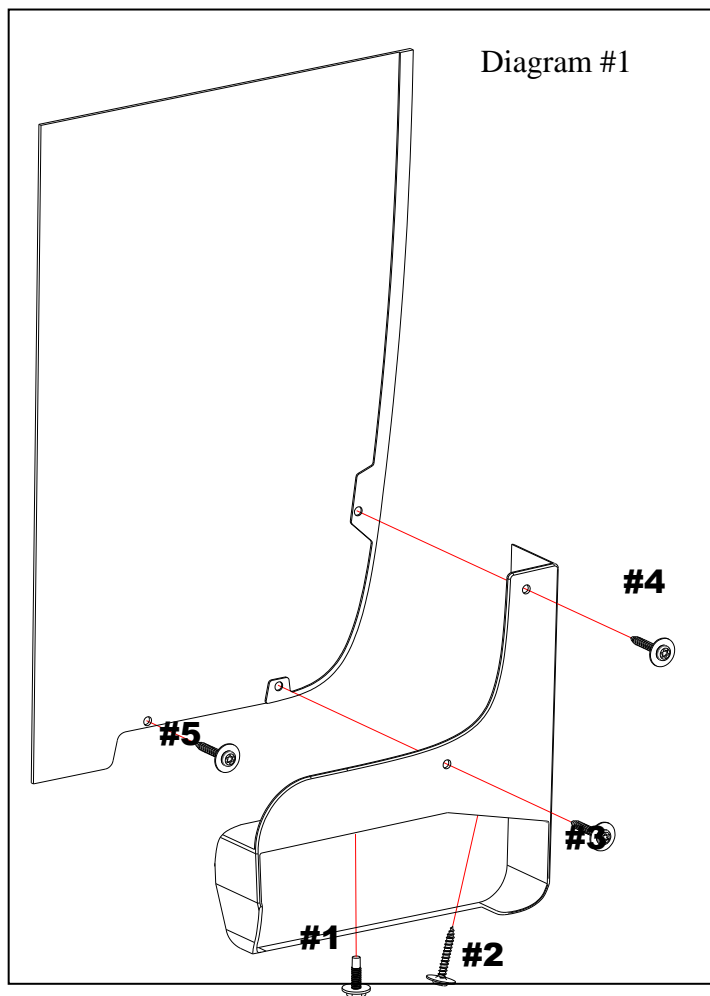

Please check out our YouTube channel to see an install video for this application.





**2019-2020 Chev Silverado**  
**Nylon 5/8" Offset Mud Flap Set, Rear**  
**Mounting Diagram & Instructions**  
**Kit# GCN28R**

**IMPORTANT:**

*Manufacturer is not responsible for negligent use of vehicle with mud flaps installed, including over-tightening of screws and bolts causing damage to vehicle or mud flaps.*



**TOOLS REQUIRED-**

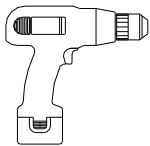

*Electric or Rechargeable Drill*



*1/4" Drill Bit*

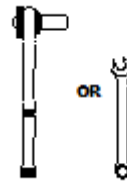

*5/16" Open Wrench or Socket Wrench*

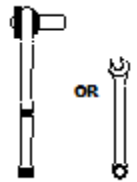

*7/16" Open Wrench or Socket Wrench*

**FLAPS**

*(1) Flap Assy Rear, DS Part #*

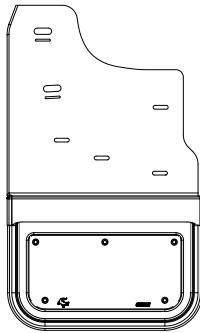

*(1) Flap Assy Rear, PS Part #*

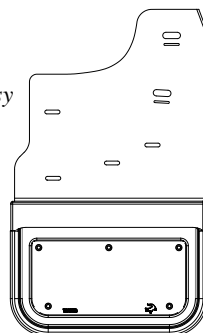

*(1) Bracket Rear, DS Part #767066*

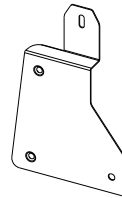

*(1) Bracket Rear, PS Part #767067*

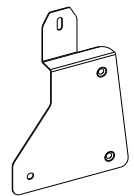

**PARTS BAG #769189**

*a) (4) Washer, Flat 0.281" x 1", 18g, SS, oxid. Part #018069*



*b) (8) Washer, Flat 0.203" x 1", 18g, SS, oxid. Part #018070*



*c) (4) Capscrew, SS 1/4"-20UNC x 3/4" Part #014070*



*d) (8) Bolt, Hex Flange, SS M 4.2 x 1", Black Part # 016041*

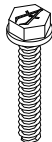

*e) (2) Mount Clip, DS w/Clinch Nut Part # 767068*

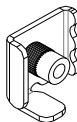

*f) (2) Mount Clip, PS w/Clinch Nut Part #767069*

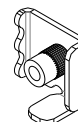

*g) (2) Rad Grill Nut #8 Thread, Zinc Pltd Part # 016049*

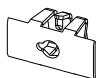

**Note:** Part #016049 is used only on vehicles **without** factory liner

## INSTALLATION *(For ease of installation it is suggested that the wheel be removed)*

1. Before you install your Mud Flap Set, see the diagram and parts list for all necessary parts. Start on driver's side.
2. Remove factory screws from factory guard. \*Removal process may vary dependent on the factory guard style.\* If 3M tape has been used to install the factory guard, use alcohol on a microfiber cloth to remove.
3. For vehicles **with** liners, remove factory screw from hole #1.
4. For vehicles **without** liners, install clip (g) into hole #1 as shown in Diagram A-1.
5. Install mount clips (e) on holes #12 & #13 using supplied bolts (c) and washers (a) See Diagram A-2.
6. Loosely install the bracket through hole #4 into hole #1 using a previously removed factory screw. (For trucks without liners, reuse factory screw from hole #3.)
7. Loosely secure the mud flap through hole #8 to bracket hole #6 using supplied bolt (d) and oxidized washer (b).
8. Loosely install clips (e) behind fender lip.
9. Loosely secure mud flap hole #10 to the bracket hole #5 using supplied bolt (d) and oxidized flat washer (b).
10. Loosely install mud flap through hole #9 through bracket hole #7 to factory hole #2 using supplied bolt (d) and oxidized washer (b)
11. Loosely secure mud flap hole #11 to factory hole #3 using supplied bolt (d) and washer (b)
12. Using a bubble level or other levelling tool, ensure that the mud flap is level. Tighten all fasteners.
13. Repeat on passenger side.

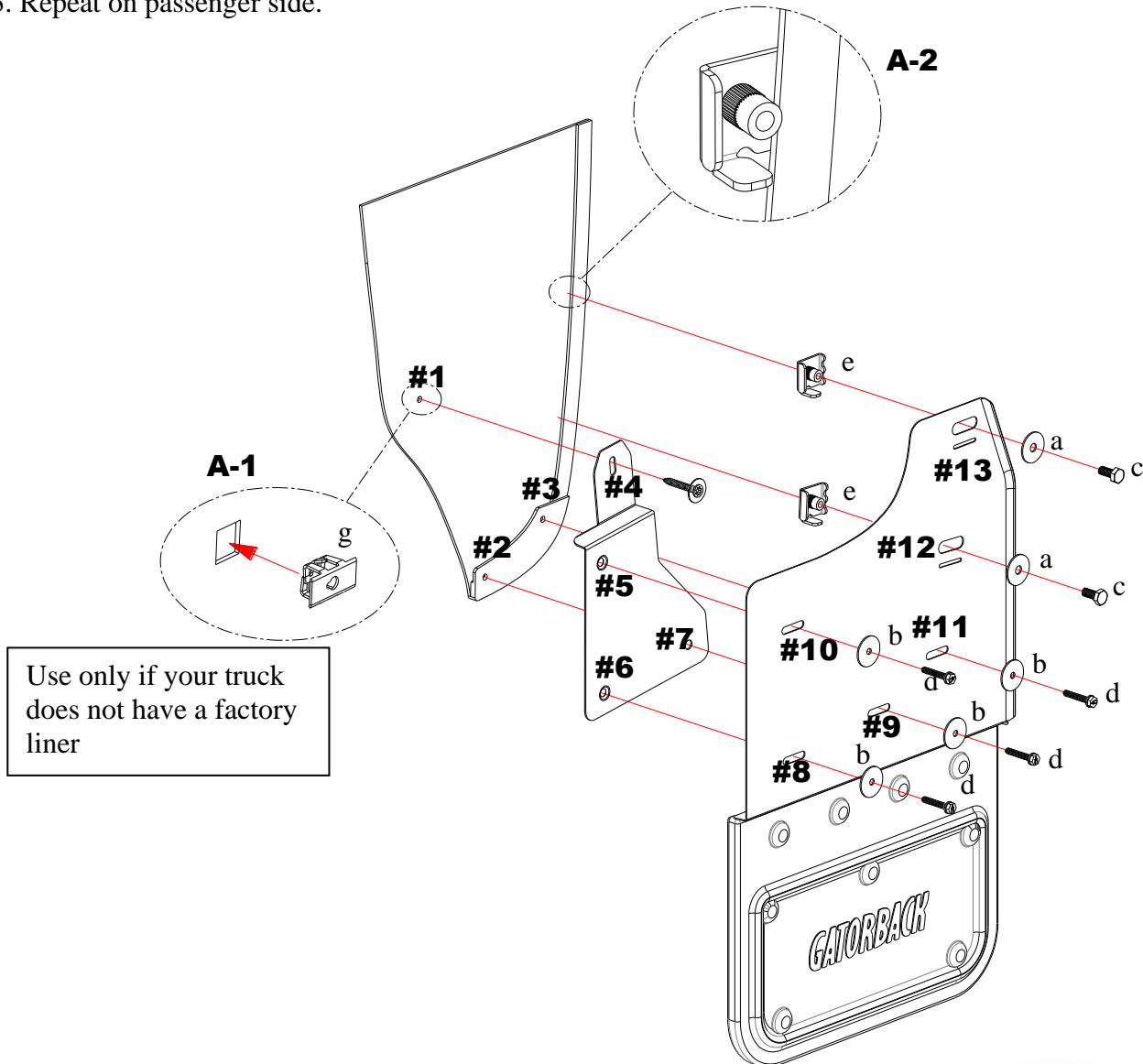

Please check out our YouTube channel to see an install video for this application.

