



2020 Silverado HD
Mud Flap Set, Front
Mounting Diagram & Instructions
Kit# GCR203F

TO BE USED WITH SIERRA CAP PART #FC002K

IMPORTANT:

Manufacturer is not responsible for negligent use of vehicle with mud flaps installed, including over-tightening of screws and bolts causing damage to vehicle or mud flaps.

TOOLS REQUIRED-

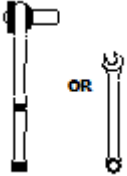

7/16" Open Wrench or
Socket Wrench

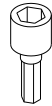

1/4" Socket Driver

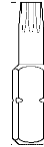

T15 Torx
Bit

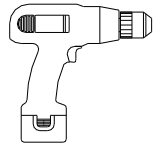

Electric or Rechargeable
Drill

FLAPS

(1) Flap Assy
Rear, DS

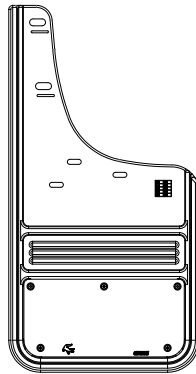

(1) Flap Assy
Rear, PS

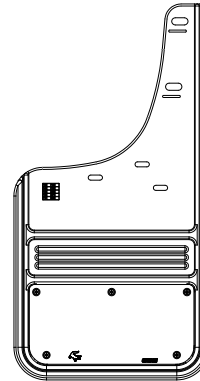

PARTS BAG # 769352

a) (2) Washer, Flat
0.203" x 0.885" Nylon
Part #054080

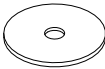

b) (4) Capscrew, Blk Ox.
1/4"-20UNC x 5/8"
Part #014071



c) (4) Screw, Blk Ox.
1/4" Hex Head, #8-18x1"
Part # 016055



d) (2) Washer, HDPE
5/16" x 1" x 1/4"
Part #018036



e) (2) "Z" Clip
0.281" x 1", 18g SS
Part #018067

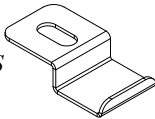

f) (4) Washer, Flat
0.281" x 1.5", Blk Ox.
Part #018079

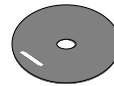

g) (6) Washer, Flat
0.203" x 1" 18g Blk Ox.
Part #018070

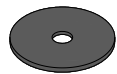

h) (2) Mud Flap Clip
Driver Side
Part # 769312

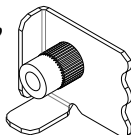

i) (2) Mud Flap Clip
Passenger Side
Part #769313

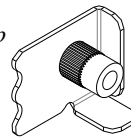

j) (2) Screw, Sht. Mtl. Blk. Ox.
1/4" Hex Hd. #8-18 x 1-1/4"
Part #016061



SOLD SEPARATELY FC002K:

(1) Molded Cap
Driver's Side

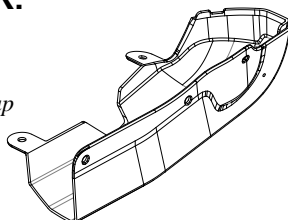

(1) Molded Cap
Passenger's Side

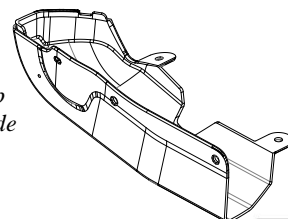

INSTALLATION *(For ease of installation it is suggested that the wheel be removed)*

CAPS:

1. Remove the 5 factory screws from the existing factory guard. Set this hardware aside for later reinstallation.
2. Gently pull the flare molding away from the body of the truck, and then quickly pull the guard down and away from the body of the truck to release the clip on the inside of the factory guard.
3. Slightly peel back the red 3M tape on the finishing cap and fold back so it can be fully peeled after cap is in place.
4. Position cap, ensuring the top lip of the cap slides under the fender molding as shown.
5. If installing Gatorback Mud Flaps, reinstall the two factory screws on the underside and back of the finishing cap. If no flaps are being installed, reinstall the five factory screws to secure the cap. Be careful not to overtighten.
6. Finish peeling 3M tape and press firmly on the bottom and side of the finishing cap to ensure a proper seal.
7. Repeat procedure on passenger side.

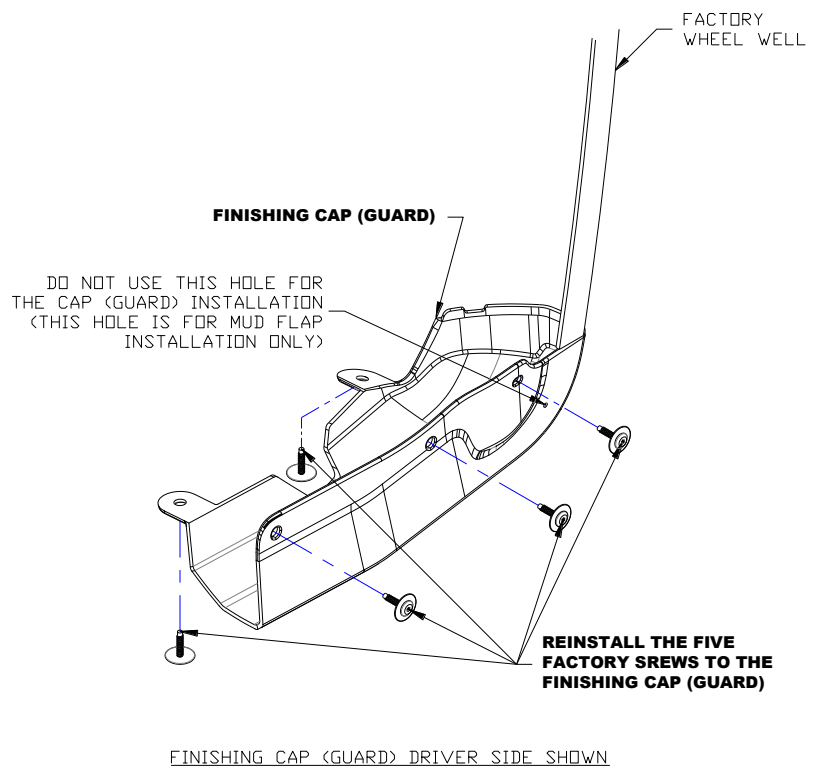
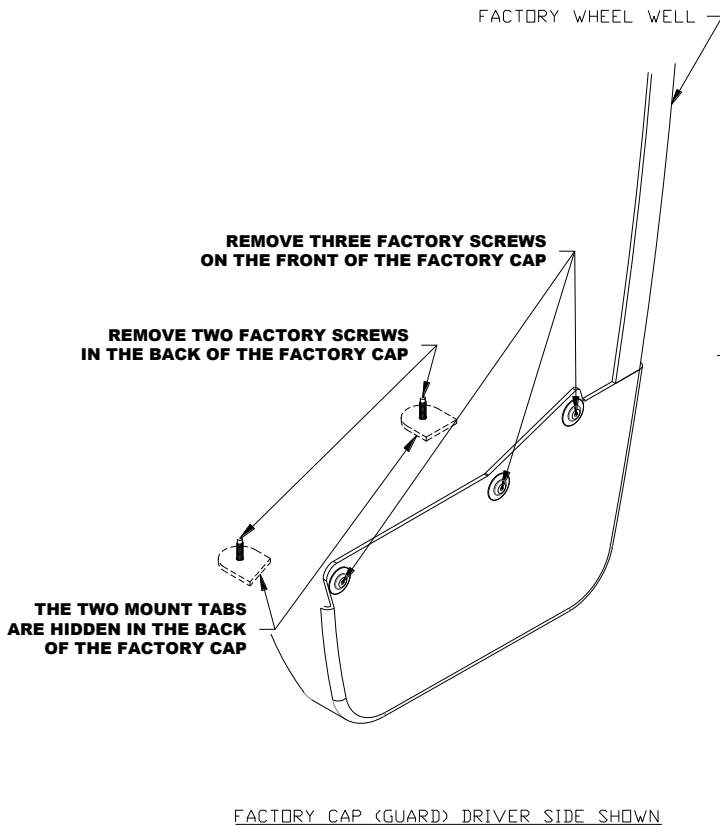

MUD FLAPS:

1. Before you install your Mud Flap Set, see the diagram and parts list for all necessary parts. Start on the driver's side.
2. Loosely install mount clip (h) on mud flap hole #1 & #2 using a cap screw (b) and flat washer (f).
3. Loosely secure mud flap through hole #5 to finishing cap hole #8 using screw (j), flat washer (g), and spacer (d).
4. Install mount clip on hole #1 & #2 behind the fender lip.
5. Secure mud flap through hole #4 into finishing cap hole #7 using supplied screw (c) and flat washer (g).
6. Using a bubble level or other levelling tool, ensure that the mud flap is level. Tighten fasteners. Ensure that the factory clips are aligned with the finishing cap.
7. Install the "Z" bracket (e) to finishing cap hole #9 using previously removed factory screw, and nylon washer (a).
8. Install mud flap hole #3 to finishing cap hole #6 using screw (c) and flat washer (g).
9. Repeat procedure for passenger side.

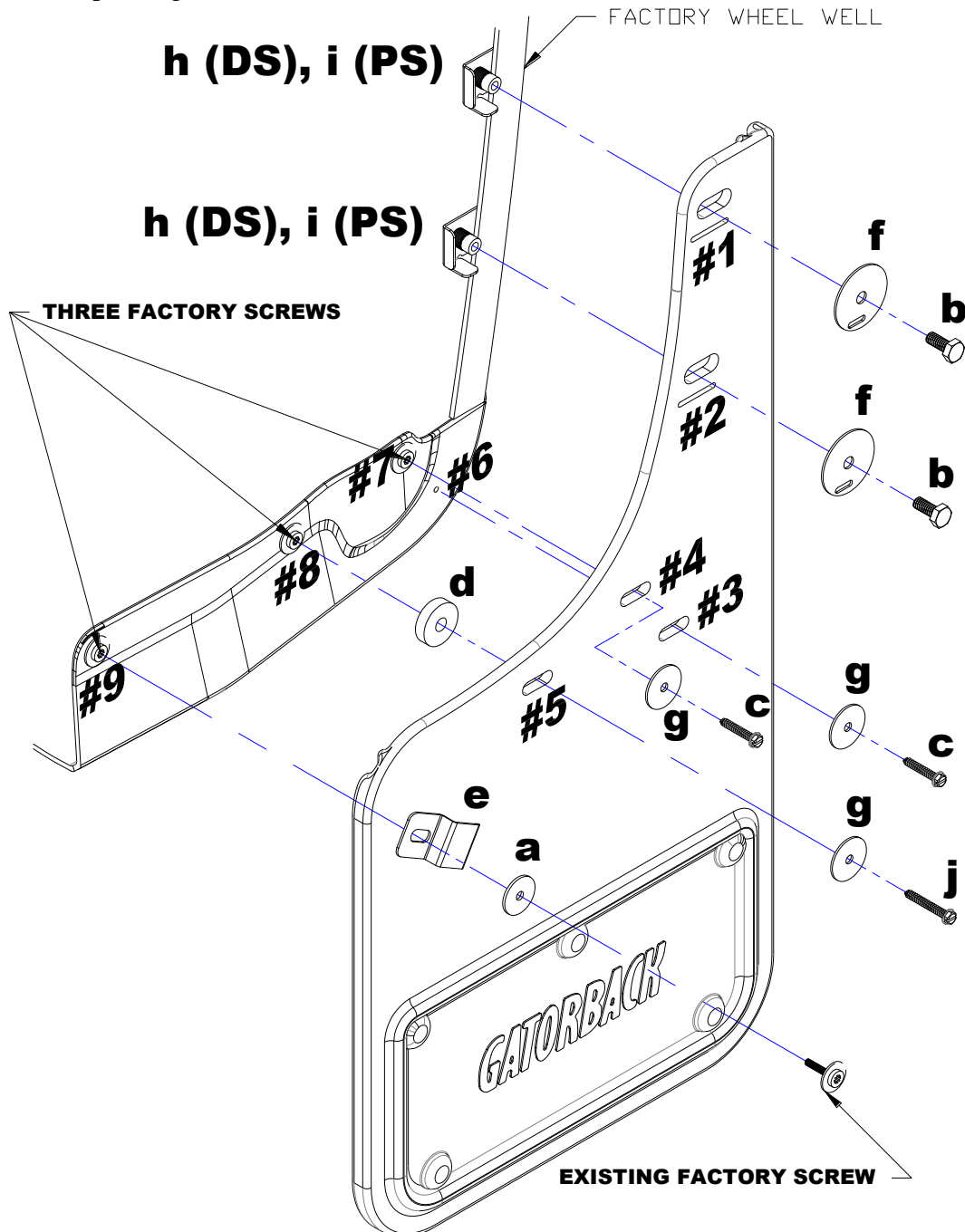

Please check out our YouTube channel to see an install video for this application.



Silverado Front