



2016-2019 Nissan Armada
Mud Flap Set, Front
Mounting Diagram & Instructions
Kit# GCR52F

IMPORTANT:

Manufacturer is not responsible for negligent use of vehicle with mud flaps installed, including over-tightening of screws and bolts causing damage to vehicle or mud flaps.



TOOLS REQUIRED-

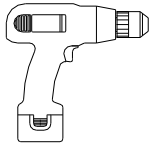

Electric or Rechargeable Drill



1/4" Drill Bit



Phillips Head Bit

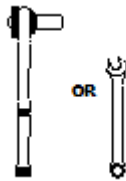

5/16" Open Wrench or Socket Wrench

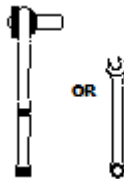

3/8" Open Wrench or Socket Wrench

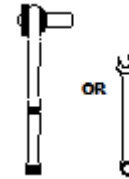

7/16" Open Wrench or Socket Wrench

FLAPS

(1) Flap Assembly, Front, DS

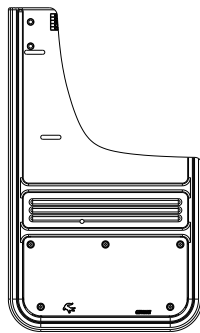

(1) Flap Assembly Front, PS

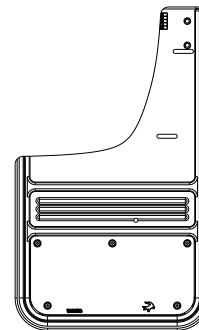

PARTS BAG # 767420

a) (4) Washer, Flat
 0.203" x 1.5", Blk Oxid.
 Part #018072

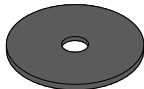

b) (2) Washer, Flat
 0.203" x 1", Blk Oxid.
 Part #018070



c) (2) Washer, Flat
 0.281" x 1", Blk Oxid.
 Part # 018069



d) (2) Washer, Flat
 0.203" x 1", SS
 Part #018031

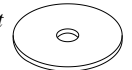

e) (2) Screw, Machine
 18-8SS, 10-24x1, Hex Hd
 Part #012022

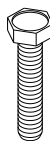

f) (4) Screw, Sheet Metal
 #10-12 x 1-1/4" Phillips Head, SS
 Part # 010027

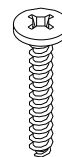

g) (2) Capscrew
 1/4"-20 x 1", Blk Oxid.
 Part # 014073

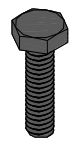

h) (2) Washer, Lock
 18-8SS, Helicoil
 Part #024001



i) (2) Nut, Hex
 #10-24, SS
 Part #025003



j) (2) Flange Nut
 1/4"-20, SS, Serrated
 Part #025034



INSTALLATION *(For ease of installation it is suggested that the wheel be removed)*

1. Before you install your Mud Flap Set, see the diagram and parts list for all necessary parts. Start on the driver's side.
2. Remove the two factory screws, and one factory push pin from the inner fender well
3. Loosely install the mud flap through hole #1 & #2 into the existing factory holes using a stainless steel screw (#010027), and a 1.5" black stainless steel washer (#018072).
4. Using a bubble level or square, ensure that the mud flap is level. Viewing the vehicle from the back, the outer edge of the mud flap should appear parallel to the tires.
5. Drill through hole #4 into factory liner and secure mud flap with a capscrew (#014073), flat washer (#018069) and serrated flange nut (#025034).
6. Loosely install the mud flap through hole #3 into factory push pin hole using a 3/4" black stainless steel washer (#018070), and machine screw (#012022). Secure with a stainless steel washer (#018031), a lock washer (#024001), and a hex nut (#025003).
7. Ensure that the mud flap is still level. Carefully tighten all screws.
8. Repeat procedure for the passenger side.

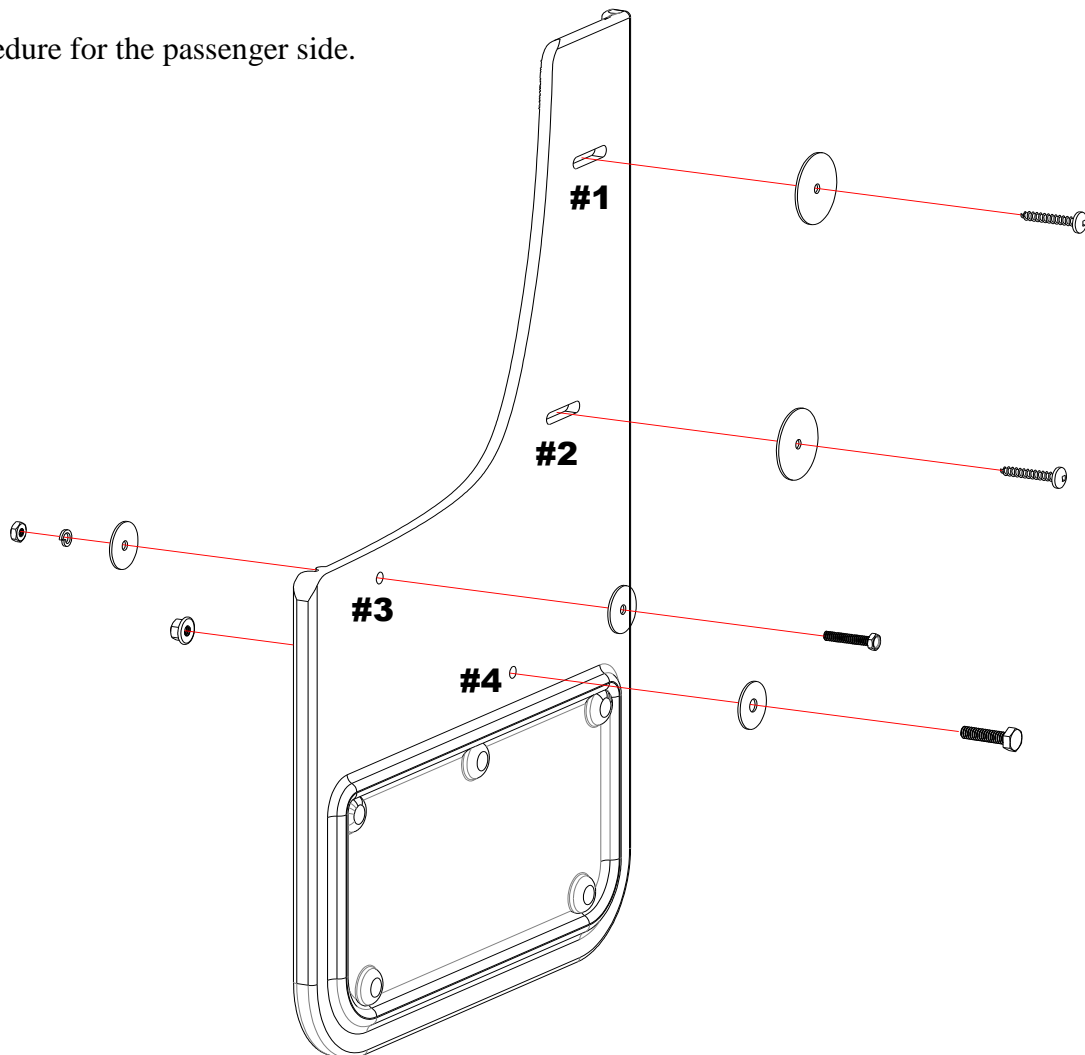

Please check out our YouTube channel to see an install video for this application.





2016-2019 Nissan Armada
Mud Flap Set, Rear
Mounting Diagram & Instructions
Kit# GCR52R

IMPORTANT:

Manufacturer is not responsible for negligent use of vehicle with mud flaps installed, including over-tightening of screws and bolts causing damage to vehicle or mud flaps.



TOOLS REQUIRED-

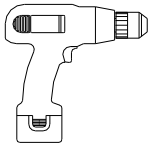

Electric or Rechargeable Drill



1/4" Drill Bit

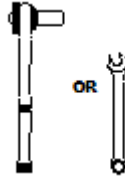

7/16" Open Wrench or Socket Wrench



Phillips Head Bit

FLAPS

(1) Flap Assembly, Rear, DS

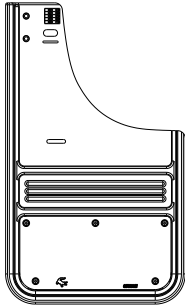

(1) Flap Assembly, Rear, PS

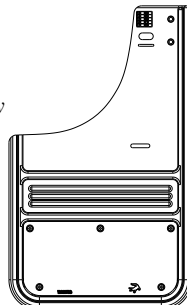

*(1) Brace, Rear, DS
Part #766021*

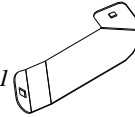

*(1) Brace, Rear, PS
Part #767022*

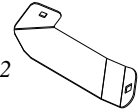

PARTS BAG # 767421

*a) (2) Washer, Flat
0.203" x 1.5", Blk Oxid.
Part #018072*

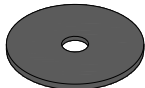

*b) (4) Washer, Flat
0.281" x 1", Blk Oxid.
Part #018069*

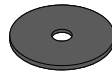

*c) (2) Washer, Flat
0.281" x 1", SS
Part #018028*

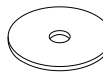

*d) (4) Washer, Flat
0.318" x 1" Nylon
Part #054061*

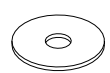

*e) (2) Screw, SM
#10-12 x 1-1/4", SS
Part # 012027*



*f) (2) Capscrew
1/4"-20UNC x 3/4", Blk Oxid.
Part #014070*

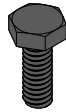

*g) (2) Capscrew
1/4"x20 x 1", Blk Oxid.
Part #014073*

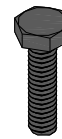

*h) (2) J-Clamp
1.5" x 2.5"
Part #767417*

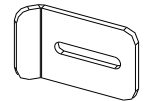

*i) (2) Nut, Hex
1/4-20, SS
Part # 025000*



*j) (2) Washer, Lock
Helicoil, SS
Part #024000*



*k) (1) Mount Clip, DS
w/Clinch Nut
Part # 767068*

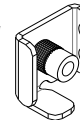

*l) (1) Mount Clip, PS
w/Clinch Nut
Part #767069*

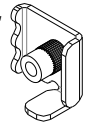

INSTALLATION *(For ease of installation it is suggested that the wheel be removed)*

1. Before you install your Mud Flap Set, see the diagram and parts list for all necessary parts. Start on driver's side.
2. Remove the factory screws from the inner wheel well, and the underside of the fender.
3. Install the bracket between the plastic molding and the body of the vehicle on the underside of the fender, using a nylon washer (054061) to separate the bracket from the body. Ensure that the holes in the washer and bracket align with the factory hole in the plastic molding and body of the vehicle and reinstall the factory screw.



4. Insert mount clip into mud flap hole #1 and loosely install j-clamp (767417) using a black washer (018069), nylon washer (054061) & capscrew (014070).
5. Loosely install mud flap through hole #2 into factory hole using a large black washer (018072) & screw (012027).
6. Slide mounting clip behind fender, pinching it between the clip and the mud flap. Position j-clamp so that the outer edge of the clip aligns with the outer edge of the fender. This is to apply pressure to ensure that the flap is tight against the wheel well.
7. Using a bubble level or square, ensure that the flap is square.
8. Secure all fasteners.
9. Ensure that the previously installed bracket is positioned correctly, adjusting if needed
10. Drill a ¼" hole through the bracket hole into factory liner.
11. Install bracket to mud flap through hole #3 using a capscrew (014073), washer (018069) and secure with a stainless steel washer (018028), lock washer (024000) and hex nut (025000).
12. Tighten all fasteners.
13. Repeat procedure for the passenger's side.

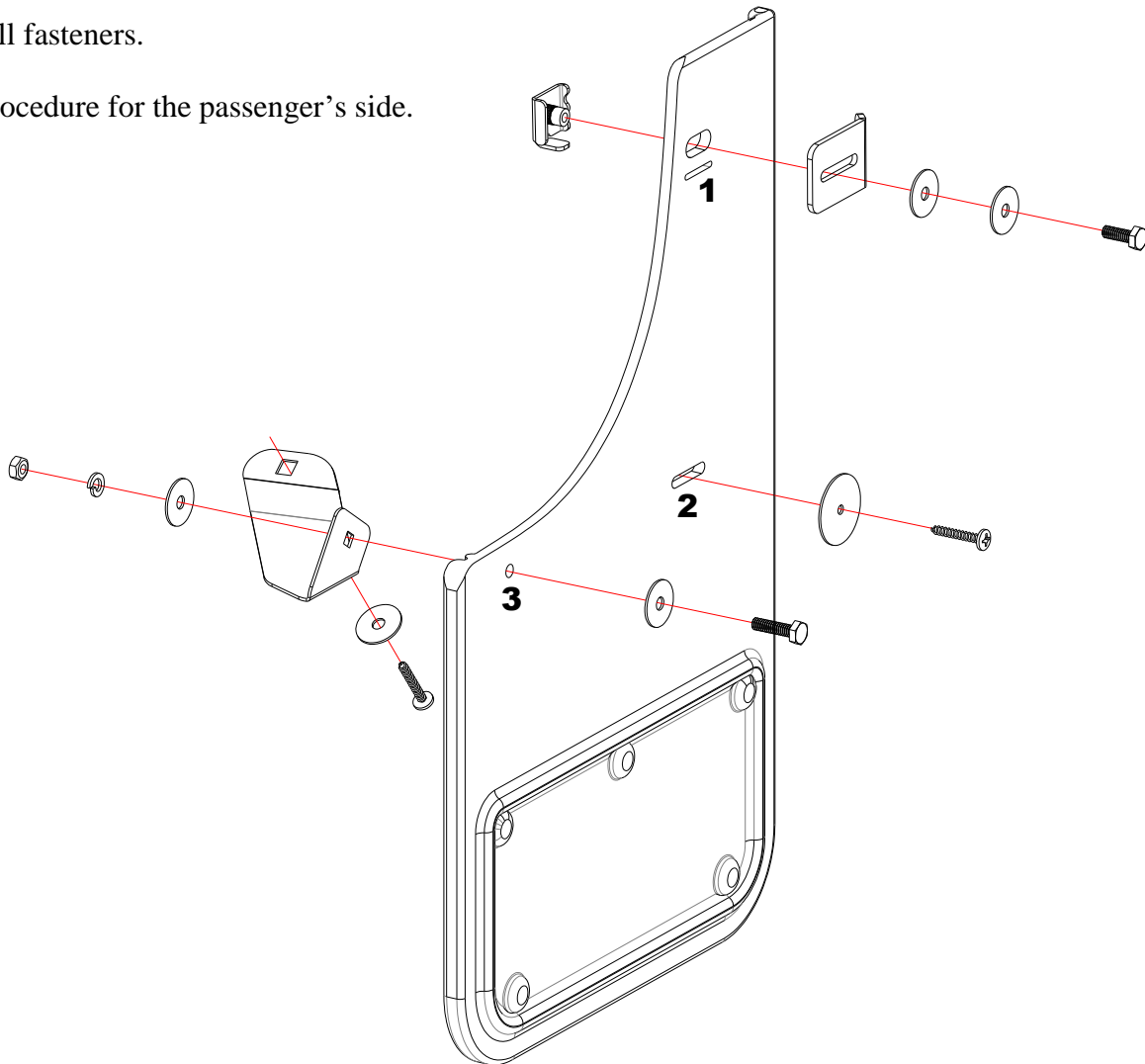

Please check out our YouTube channel to see an install video for this application.

